

Power Quality and Utilisation Guide

Distributed Generation and Renewables

8.3.1 Integration and interconnection

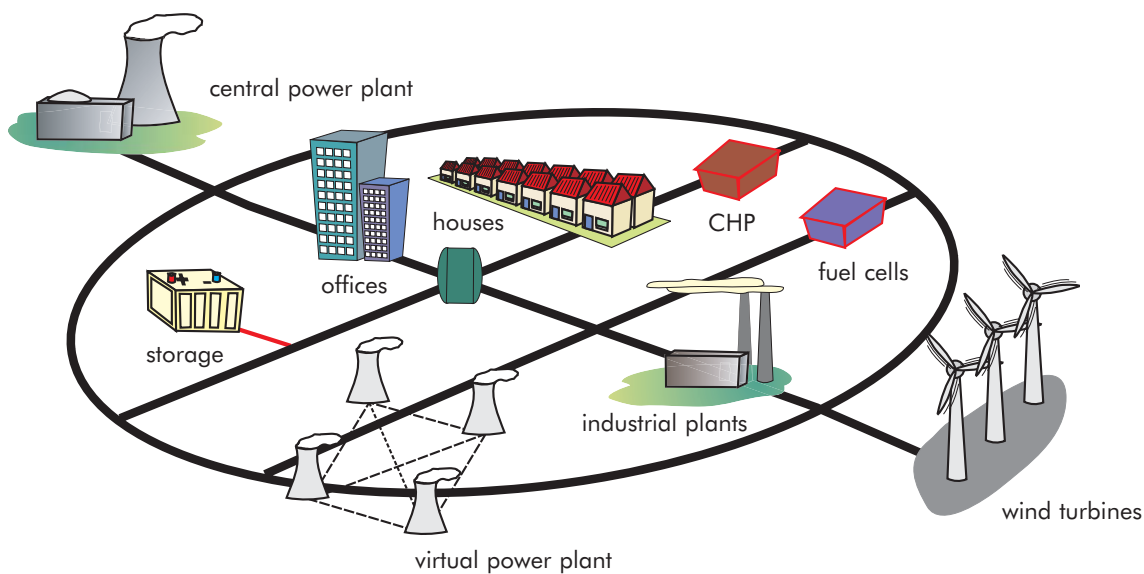

Distribution Generation and Renewables

Integration and interconnection

Jan Bloem
KEMA Nederland B.V
May 2007

Leonardo ENERGY



Leonardo ENERGY is an initiative managed by the European Copper Institute and its European network of 11 offices, dedicated to building information centres to serve designers, engineers, contractors, architects, general managers, teachers and students, who are professionally or otherwise involved with electrical energy. Through various projects, including the award-winning Leonard Power Quality Initiative, over 130 partners from leading academia and industry are involved with Leonardo ENERGY. The website www.leonardo-energy.org delivers a range of virtual libraries on a broad range of electrical energy related topics providing users with regularly updated articles, application notes, briefing papers, reports and interactive training.



Copper Development Association (CDA)

Copper Development Association is a non-trading organisation sponsored by the copper producers and fabricators to encourage the use of copper and copper alloys and to promote their correct and efficient application. Its services, which include the provision of technical advice and information, are available to those interested in the utilisation of copper in all its aspects. The Association also provides a link between research and the user industries and maintains close contact with the other copper development organisations throughout the world.

CDA is an IET endorsed provider of seminar training and learning resources.



European Copper Institute (ECI)

The European Copper Institute is a joint venture between the world's mining companies (represented by the International Copper Association, Ltd (ICA) and the European copper industry. Through its membership, ECI acts on behalf of the world's largest copper producers and Europe's leading fabricators in promoting copper in Europe. Formed in January 1996, ECI is supported by a network of 11 Copper Development Associations (CDAs) in Benelux, France, Germany, Greece, Hungary, Italy, Poland, Russia, Scandinavia, Spain and the UK. It furthers the efforts initially undertaken by the Copper Products Development Association, formed in 1959, and INCRA (International Copper Research Association) formed in 1961.

Disclaimer

The content of this project does not necessarily reflect the position of the European Community, nor does it involve any responsibility on the part of the European Community.

European Copper Institute, KEMA Nederland B.V and Copper Development Association disclaim liability for any direct, indirect, consequential or incidental damages that may result from the use of the information, or from the inability to use the information or data contained within this publication.

Copyright© European Copper Institute, KEMA Nederland B.V and Copper Development Association. Reproduction is authorised providing the material is unabridged and the source is acknowledged.

LE and LPQI are promoted in the UK by members of the Power Quality Partnership:



Distributed Generation and Renewables

Integration and interconnection

Introduction

Traditional electricity networks were built to transport electrical energy from a relatively small number of large, centralised power generation units to a very large number of distributed loads. Power flows are essentially in one direction - from centralised generator to distributed load. This arrangement is shown in Figure 1. Now, relatively small distributed generation (DG) units are being added to these distribution networks even though they were not designed to host power generators. In this type of scenario, shown in Figure 2, power flows are no longer uni-directional. However, most studies confirm that the electricity network can easily absorb 10 – 15% penetration of DG without requiring major structural changes, although integration will need to be carefully controlled.

Three independent trends are currently driving the possible widespread adoption of DG:

- ◆ restructuring of the utility industry, allowing open access to the market
- ◆ the political will to increase the use of RES (Renewable Energy Sources) which are particularly suitable for distributed, rather than concentrated, use.
- ◆ advances in technology.

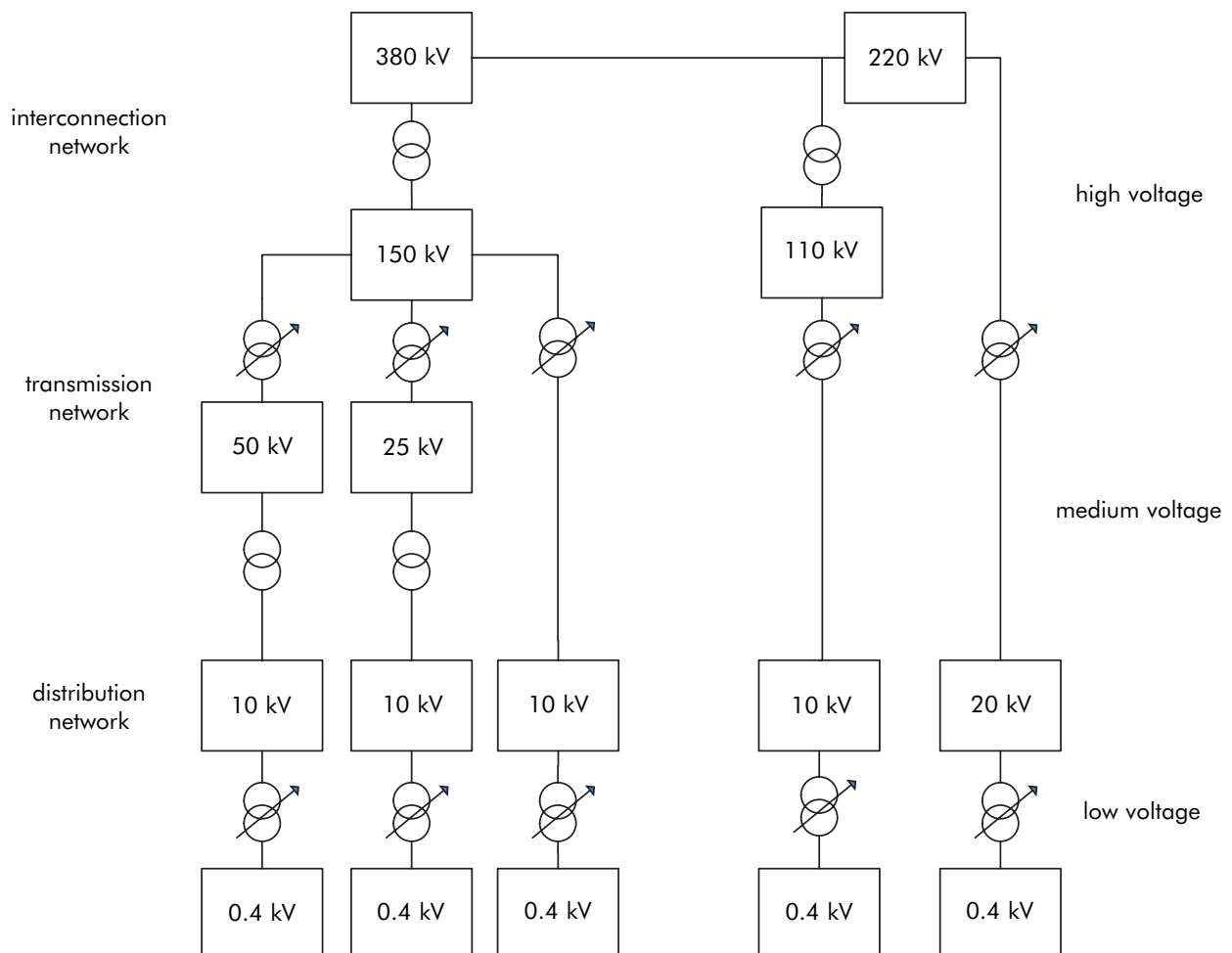

Figure 1 - A typical electricity network with centralised generation on the 380kV transmission network

Integration and interconnection

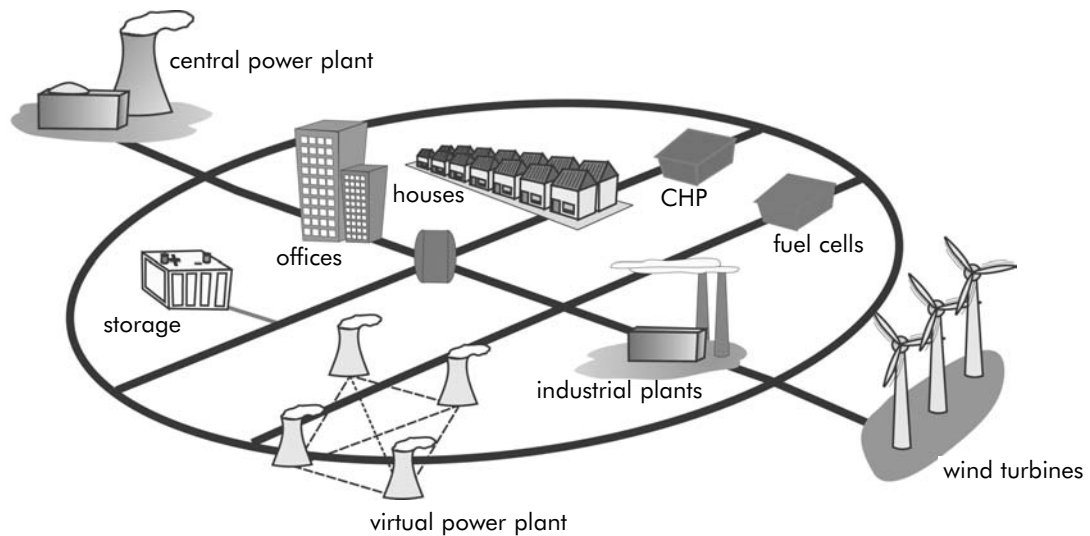

Figure 2 - The electricity network of the future; "Energy Web Concept" in which different DGs feed in to an electricity web, mainly at the distribution voltage level

Definitions of integration and interconnection

Integration

Integration is the addition of DG to the power grid at the system level. Important integration issues are:

- ◆ protection systems
- ◆ connection standards
- ◆ power electronics
- ◆ power quality issues
- ◆ simulation and computer modelling.

Interconnection

DG units can be 'grid independent' or 'grid parallel' or a combination of both of these. In the latter case, the DG unit normally operates in grid parallel mode but when a grid failure occurs, the DG unit is disconnected from the grid and continues to operate independently as an 'island'.

A typical arrangement for the DG interconnection to the medium voltage network is shown in Figure 3. Connection and disconnection of the generator is made by the circuit breaker at the generator side of the main power transformer (main breaker). Depending on the size of the plant, the disconnector on the grid side of the transformer may be replaced by a circuit breaker.

Considering only the electrical characteristics, there are three different types of DG:

- ◆ synchronous generator
- ◆ asynchronous generator
- ◆ electronic inverter.

The general scheme presented in Figure 3 illustrates interconnection of DG technologies based on synchronous or asynchronous generators. Other DG technologies require the application of slightly different interconnection arrangements. In all cases, the need for a transformer is determined by the voltage level at the interconnection point. Smaller units can be directly connected to the low voltage network.

Integration and interconnection

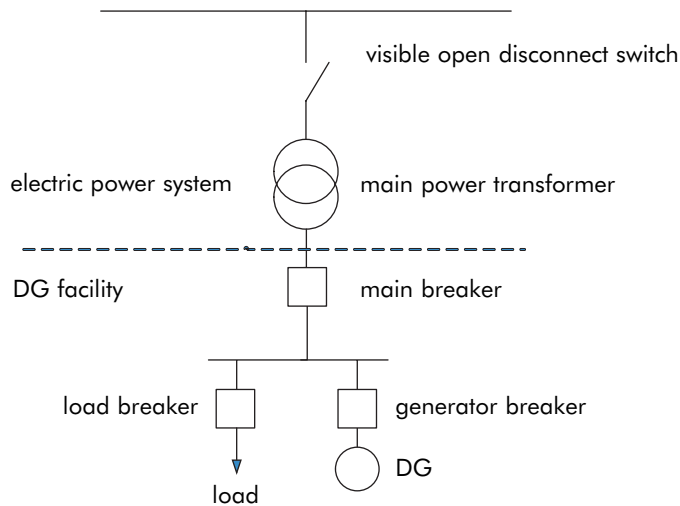

Figure 3 - Interconnection of DG technologies based on synchronous or asynchronous generators

The first two types represent traditional technology based on rotating electrical machines while the third covers a variety of power electronic converters. From the interconnection point of view, these three types have different impacts on the distribution network.

Application of integration and interconnection

Operator issues

The operator of a DG unit must comply with the interconnection requirements of the utility and/or regulatory authority, which is responsible for the integrity of the distribution system. Requirements may be imposed to ensure reliability, safety and power quality and an analysis of protection issues and power flows may be necessary.

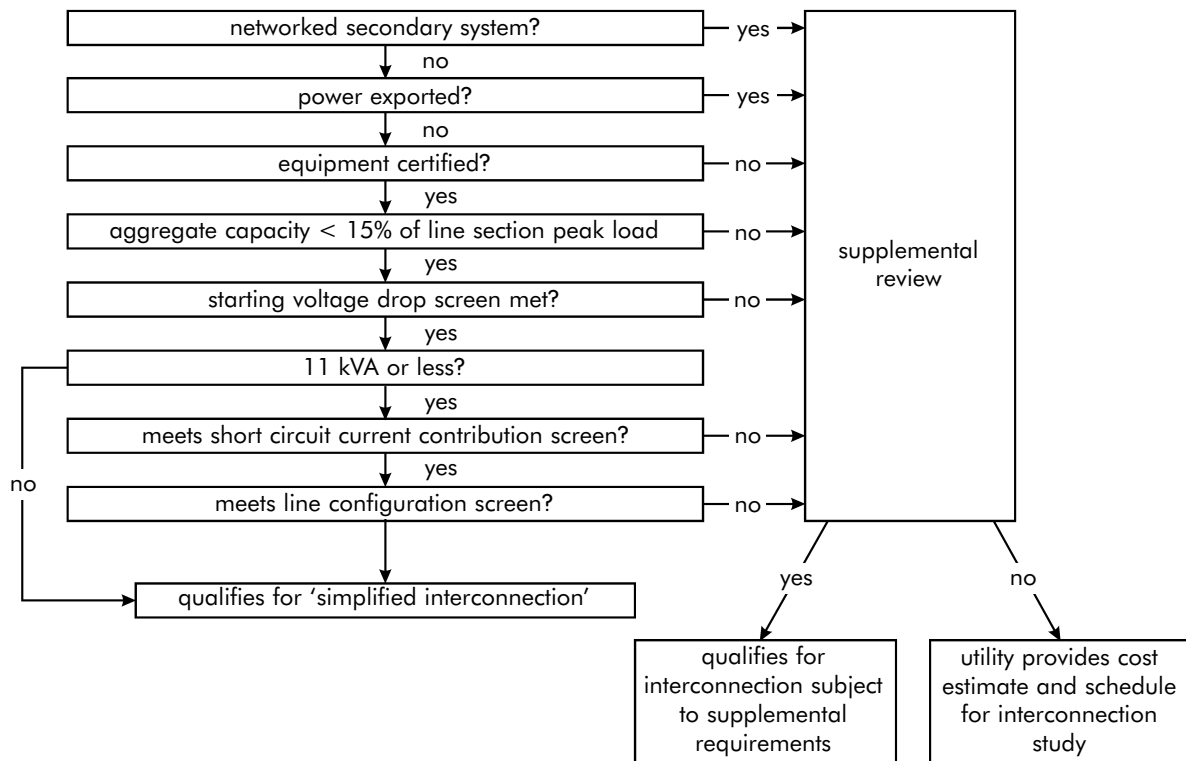

Figure 4 - An example flowchart of requirements for interconnecting DG resources

Integration and interconnection

Network issues

For many years the electric power industry has been driven by a paradigm where almost all electricity was generated by large, central power plants, delivered to the consumption areas over transmission lines, and distributed to the consumers through the passive distribution infrastructure at lower voltage levels. In this system, power flows were in one-direction, i.e. from higher to lower voltage levels. This is indicated on the left-hand side of Figure 5.

Now this model is changing to a bi-directional distributed generation network. This is indicated on the right-hand side of Figure 5.

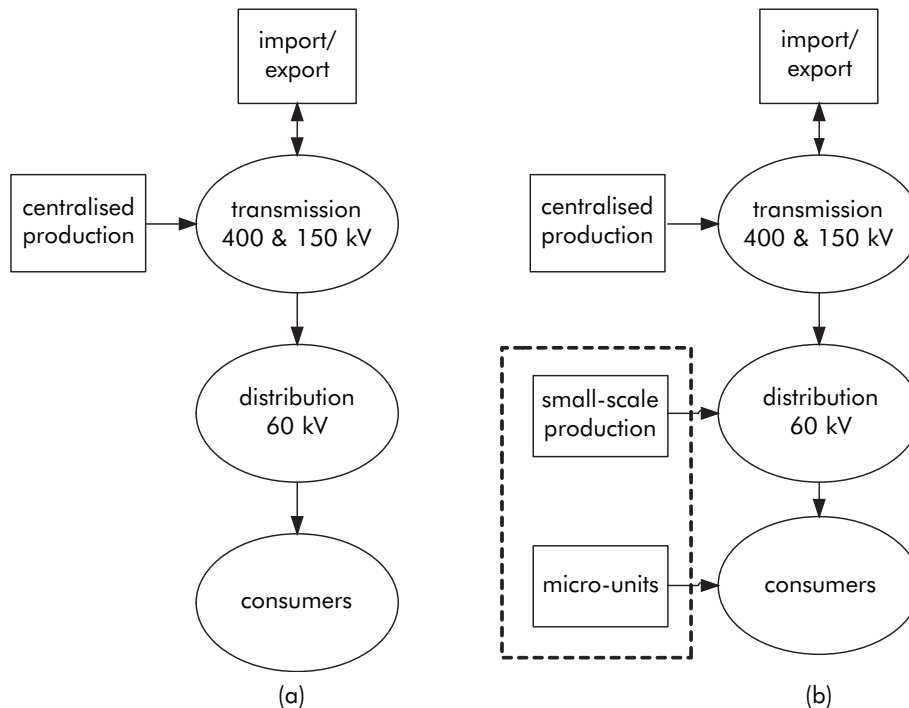

Figure 5 – a) A uni-directional centrally delivered power generation system and b) a bi-directional system with distributed generation

The operation of a distribution system with a large amount of distributed generation raises a number of issues:

- ◆ voltage profiles change along the network, depending on how much power is produced and consumed at that system level, leading to a behaviour different from that of a typical uni-directional network
- ◆ voltage transients will appear as a result of connection and disconnection of generators or even as a result of their operation
- ◆ short circuit levels are increased
- ◆ load losses change as a function of the production and load levels
- ◆ congestion in system branches is a function of the production and load levels
- ◆ power quality and reliability may be affected
- ◆ utility protection and DG protection measures must be co-ordinated.

When considering these problems it is important to keep in mind that the existing network design standards and regulatory frameworks are based on the old uni-directional model. They are framed to ensure that the stability of the network is maintained by the centralised – and mutually synchronised – large generation plants, providing:

Integration and interconnection

- ◆ power control
- ◆ frequency control
- ◆ load following
- ◆ voltage control
- ◆ power availability.

Generation issues

DG strategically provides relatively small generating units (typically less than 20 MWe) at, or near to, consumers. It may be provided to meet specific customer needs, to support economic operation of the existing power distribution grid, or both. The coincidence of competition in the electricity supply industry with the arrival of environmentally friendly micro-turbines, fuel cells, photo-voltaics, small wind turbines and other advanced distributed power technologies, has prompted strong interest in distributed power, particularly in on-site generation. Reliability of service and power quality may be enhanced by proximity to the customer, and efficiency is improved in on-site combined heat and power (CHP) applications where the heat by-product from power generation can be used.

Distributed generation complements traditional centralised power generation and distribution. It provides a relatively low capital cost response to incremental increases in power demand, avoids the need for transmission and distribution capacity upgrades, locates power generation close to where it is most needed and has the flexibility to put power back into the grid at user sites. On the other hand, there are social needs for cheaper, less polluting, safer and more reliable sustainable energy for all stakeholders, including consumers, suppliers, generators and policy makers. Distributed generation, including renewable energy source (RES) integration, is a promising approach to meet those needs.

Current status in EU

The 'White Paper for a Community Strategy and Action Plan', published in 1997 by the European Commission, aims to double the share of energy from renewable sources in gross domestic energy consumption in the European Union by 2010 (i.e. from the present 6% to 12%). An Action Plan defines how this objective is to be achieved. Figure 6 shows the historical share of electricity from renewable energy sources (RES-E) as a proportion of electricity consumption in EU-15 and the target for 2010.

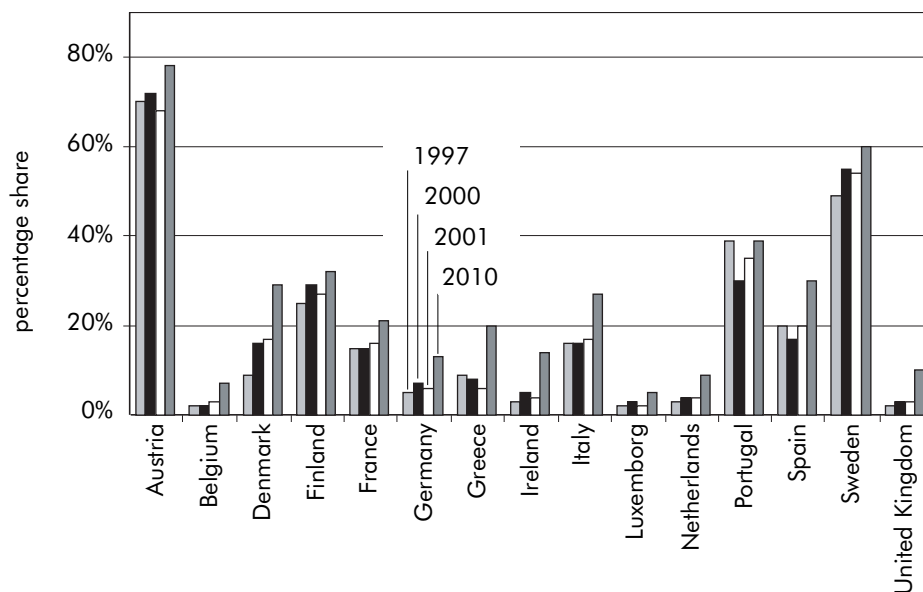

Figure 6 - Share of RES-E in total electricity consumption (Eurostat) compared to 2010 targets (RES-E Directive)

Trends

In the future, rapid growth of RES and DG is to be expected. Figure 7 illustrates the global energy mix that might be required if the concentration of CO₂ in the atmosphere is to be limited to 400ppm.

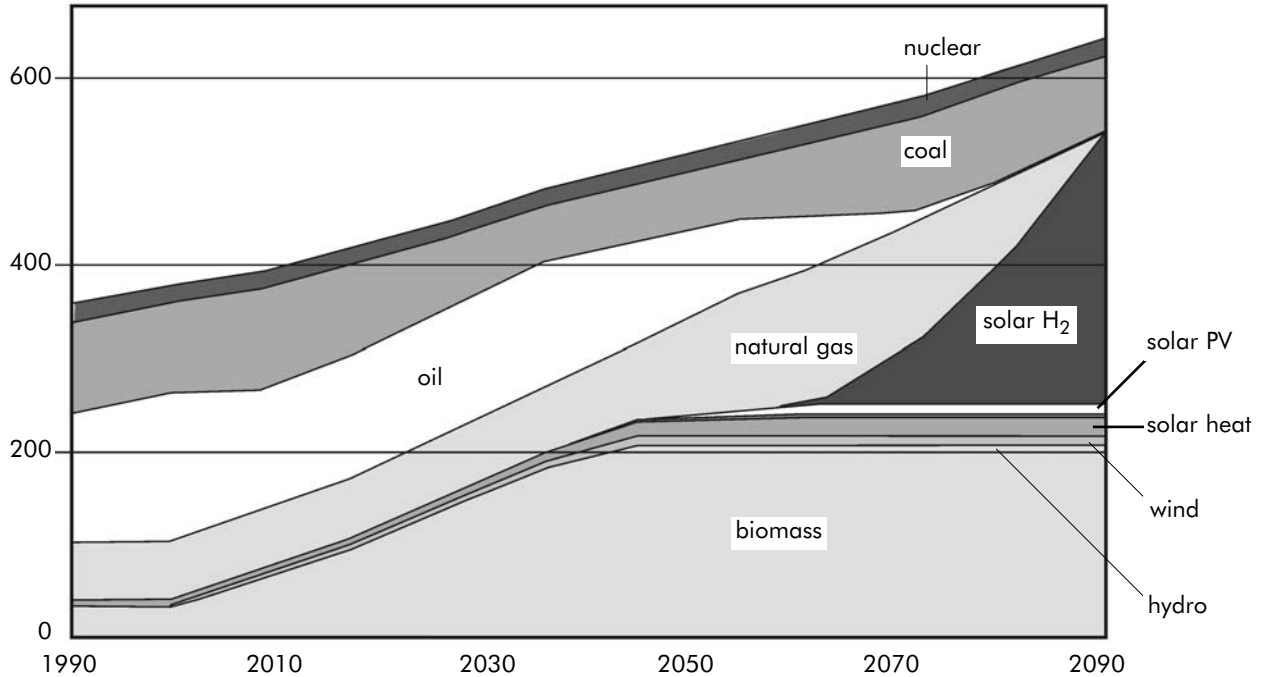

Figure 7 - Energy resources mix required if atmospheric CO₂ concentrations are to be stabilised at 400 ppm

For comparison, Figure 8 shows the current mix of primary energy demand in EU-15.

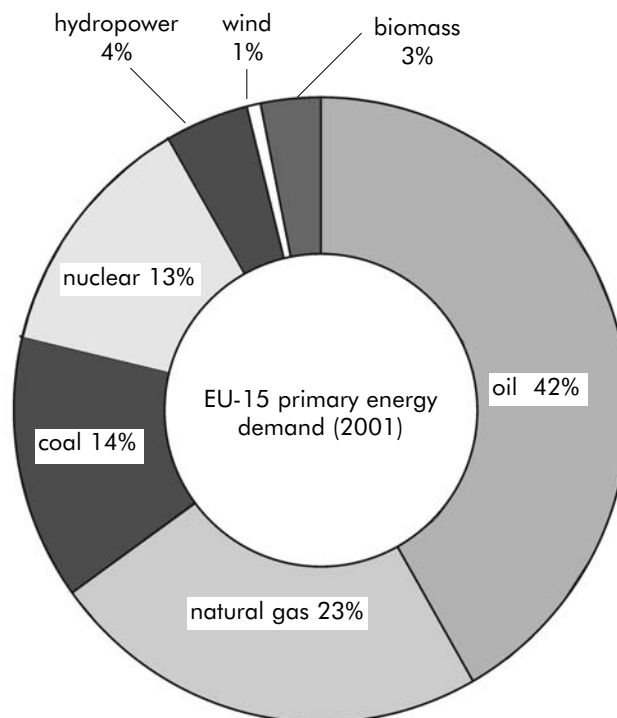

Figure 8 - Primary energy demand and energy resources in EU-15 in 2001

Figure 9 shows the predicted mix of RES-E in the EU for the near future.

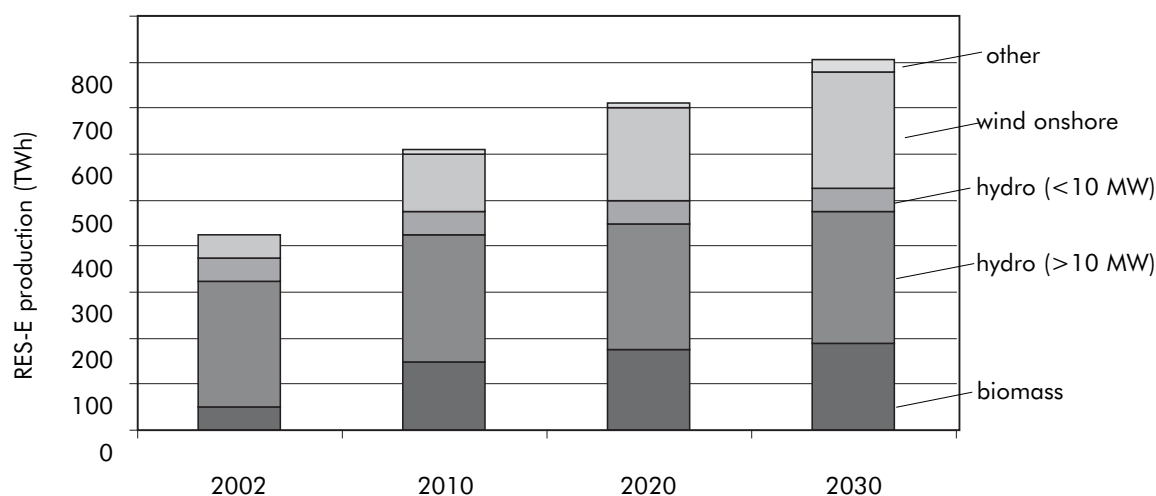

Figure 9 - Total RES-E production in the EU

Configuration and characteristics

Scale of integration and interconnection of application

Table 1 lists the technologies used for distributed generation and the typical size of a module. Table 2 indicates the characteristics of various types of DG and their typical application areas.

Technology	Typical module size
Combined combustion engines	35-400 MW
Internal combustion engines	5 kW-10 MW
Combustion turbine	1-250 MW
Micro-turbines	35 kW- 1 MW
Renewable	
Small hydro	1-100 MW
Micro hydro	25 kW-1 MW
Wind turbine	200 Watt-3 MW
Photovoltaic arrays	20 Watt-100 kW
Solar thermal, central receiver	1-10 MW
Solar thermal, Lutz system	10-80 MW
Biomass, e.g. based on gasification	100 kW-20 MW
Fuel cells, phosphoric acid	200 kW-2 MW
Fuel cells, molten carbonate	250 kW-2 MW
Fuel cells, proton exchange	1 kW-250 kW
Fuel cells, solid oxide	250 kW-5 MW
Geothermal	5-100 MW
Ocean energy	100 kW-5 MW
Stirling engine	2-10 kW
Battery storage	500 kW-5 MW

Table 1 - Typical available size per module for DG

Integration and interconnection

	Combined heat and power (CHP)	Renewable energy sources (RES)
Large scale generation	Large district heating	Large hydro
	Large industrial CHP	Off-shore wind
		Co-firing biomass in coal power plants
Distributed generation (DG)		Geothermal energy
	Medium district heating	Medium and small hydro
	Medium industrial CHP	On-shore wind
	Commercial CHP	Tidal energy
	Micro CHP	Biomass and waste incineration/gasification
		Solar energy (PV)

Table 2 - Characteristic of DG

Voltage level of integration and interconnection

Because of the uni-directional design of the traditional distribution network, the voltage reduces with distance from the generator or transformer. These voltage drops are predictable and they are taken into account in the design of the network so that the voltage is within tolerance under all normal conditions. When a DG unit is connected, the current flows are changed or even reversed, and the voltage will generally increase in a way that is not easy to predict. The requirement to meet statutory voltage limits restricts the capacity of DG that can be connected to the system, particularly at the low voltage level. This is schematically illustrated in Figure 10.

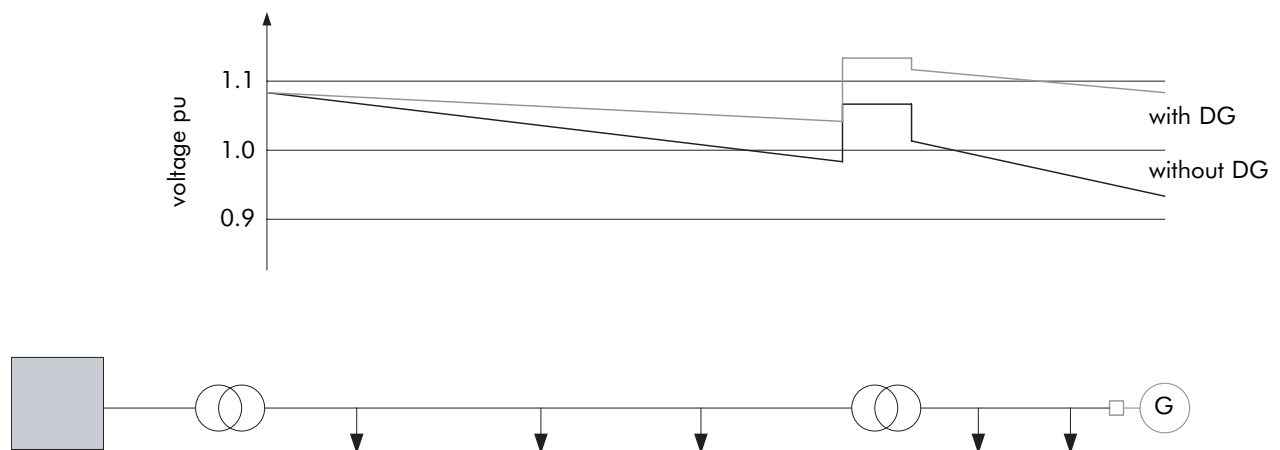

Figure 10 - Voltage rise due to reversed power flow due to DG

Quality of integration and interconnection

The proper protection of distribution networks containing DG requires several new concepts and methods to be developed. These are related to the following topics:

- ◆ loss-of-mains protection
- ◆ auto-reclosing functions
- ◆ changes in fault levels

- ◆ protection co-ordination
- ◆ earth-fault indication
- ◆ fault location.

There is a need for totally new solutions, but obviously some solutions may be adopted from the high voltage (HV) systems. An interesting topic is the protection of low voltage (LV) networks which is traditionally based on fuses. Suppose that a low power DG unit is supplying energy to a low voltage branch also supplied by a LV transformer. If a fault develops far from the DG unit the fault current from the transformer will cause the transformer protection to operate, leaving the DG unit supplying a fault current that, due to the relatively high impedance of the system, may be insufficient to operate the DG protection.

Short circuit power level

The short circuit power is determined by the properties of the grid.

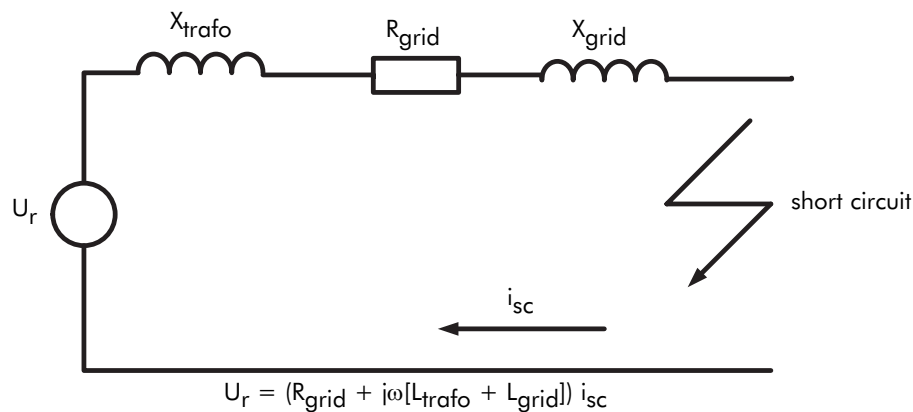

Figure 11 – Equivalent circuit of a grid branch with a short circuit

Since the value of the grid impedance will increase with the length of the line or cable, the short circuit current and power will generally decrease with the length. For a desired steady state voltage deviation of less than 2%, a ‘rule of thumb’ is often applied which states that the short circuit power should be at least 50 times the rated power. This is an approximation since it does not take into account any effects due to other producers or consumers.

Steady state voltage deviations: load flow

A more accurate determination of the steady state voltage deviation is provided by a load flow calculation in which the steady state voltages, currents and phase relations in a section of the electrical grid are determined. An example load flow calculation for a wind farm consisting of six turbines arranged in a string is shown in Figure 12.

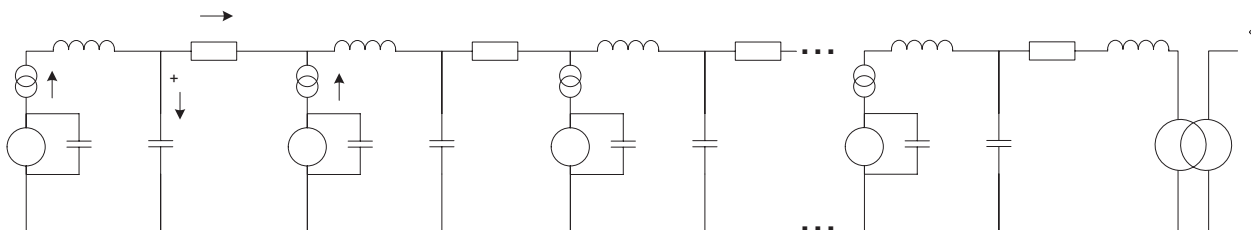

Figure 12 - An example of a wind farm consisting of six turbines arranged in a string

Integration and interconnection

The turbines are represented by an induction generator, reactive power compensation and a transformer from the 600 V level at the turbine to 6 kV of the local system. Each cable section is represented by inductance, resistance and capacitance. The cable is connected to a 6 - 150 kV transformer station through an inductor, which reduces the short circuit power of the branch to prevent overload in the transformer station.

Consumers and decentralised producers are modelled according to their active and reactive power and the voltage and current phasors are determined from the voltage equations for all transmission lines or cables in the grid section. Generally this will be an iterative process which can be considerably simplified by applying the principle of superposition (voltage and current are added vectorally since the system is considered to be linear).

Dynamic voltage deviations due to variations in generated power

Where DG depends on the supply of RES, such as wind or sunlight, or is a by-product, such as in heat demand controlled CHP, the load or capacity factor is much less than one - typically from 0.25 to 0.35 for wind farms and about 0.10 for photovoltaic systems. Although these peaks are tiny compared with the overall supply available on the grid, there is a local surplus of power which must flow to the grid via the (relatively high impedance) local network. As a result, the local voltage can rise significantly.

If these power fluctuations are fast and cyclic, they may result in the appearance of flicker. On the other hand, depending on the connection technology, DG can also contribute to short circuit level, which will reduce voltage variations – and any potential flicker - caused by intermittent loads.

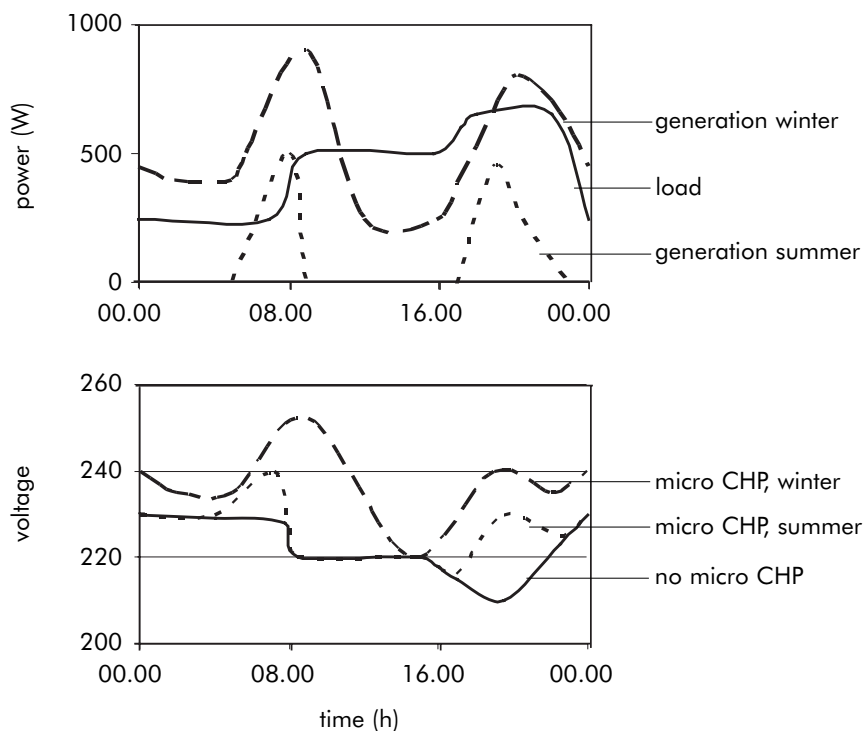

Figure 13 – Power variations and voltage fluctuations due to micro CHP installation

Voltage wave form deviations: harmonics

The connection of a DG unit to the network can influence the level of harmonic voltage distortion depending on whether it is an electronic converter or a rotating machine. Power electronics interfaces offer advanced system support possibilities, but will inject harmonic currents into the system. Depending on the

Integration and interconnection

topology of the system and the impedance at the connection point excessive voltage harmonic levels may occur locally or elsewhere in the grid. Rotating generators can also inject harmonics due to the design of the winding and core non-linearities. The relevance of this aspect depends on the grid layout and specific DG details.

Operational planning

The task of operational planning involves many activity areas to achieve the primary objective, securing the system at minimum possible costs. Involved areas are, demand forecasting, availability forecasting and outage planning. Overall, planning consists of strategic planning, net planning and net design.

Reliability

The continuing increase in demand for electrical energy, together with the international shift towards competitive electricity markets, the environmental constraints on the building of new transmission and central generation facilities has resulted in power systems being operated much closer to their stability limits than in the past. At the same time, the pressing need for higher security, reliability and power quality imposes demanding requirements on power system planning, operation and control.

The interconnection of DG to the distribution network brings many challenges, including power quality issues, network stability, power balancing considerations, voltage regulation, protection and controls, unwanted islanding, losses, reliability of DG and infrastructure capacity. The perceived technical barriers of the low and fluctuating power output of DG and the lack of utility connection standards are particularly important.

Policy and regulation

Relevant regulations (general and common in EU, not country specific)

The distribution system is a natural monopoly and, as such, has to be regulated so the regulatory framework is aimed at distribution system operators (DSOs). Regulation can be based simply on the cost-efficiency of network management or can include performance-based criteria. In the case of performance regulation, DG can be taken into account when DSOs plan extensions and upgrades of their network.

Table 3 shows typical market access for DG operators.

Market presence	Market participation	Description
Low	Protected niche	DG develops outside the regular energy market. Penetration levels are low and priority access and obligatory purchase schemes such as feed-in tariffs are the most efficient way to integrate DG.
Medium	Wholesale market	Penetration levels of DG are growing and DG can sell its energy on the wholesale market. Market conform pricing mechanisms are required, such as green certificates of premium tariffs based on the environmental benefits of DG.
High	Level playing field	Penetration levels of DG are high and dispatch problems can occur. DG should start playing a role in balancing the electricity system and contributing to power quality.

Table 3 - Market access for DG

Table 4 gives an overview of Standards and proposed Standards that relate to the integration and interconnection of DG.

Integration and interconnection

Standard reference	DG in general	Wind power	Photovoltaic	Fuel cells	Biomass	Small hydro	Microturbines	Small CHP	Batteries	Inverter & interfaces	Grid integration	Island	UPS	PQ in general	Voltage sags & interruptions	Harmonics	Flicker	EMC	Network stability	Protection	Control	Ancillary network services	FACTS	Market	Management & operations	Measurement & monitoring
EN 50160														x	x	x	x								x	
EN 561000/IEC 61000															x	x	x	x								x
EN 61400/IEC 61400															x											x
EN 50373		x																								
EN 60866																	x									x
IEC/TR 61000-2-8															x											x
IEC/TS 61000-3-4																x										
IEC/TR2 61000-3-5/ IEC/TR3 61000-3-6/ IEC/TR3 61000-3-7																			x							
IEEE 1547	x									x	x									x					x	x
prEN50438								x			x														x	
IEC/SC22GT, IEC 61800-3																										
IEC/SC22H, prEN 62310-2																										
IEEE P1547, 1																										x
IEEE P1547, 2	x									x	x															
IEEE P1547, 3	x										x										x					x
IEEE P1547, 4	x										x															
IEEE P1547, 5	x									x	x										x					

The IEEE 1547 is believed to be the most general interconnection standard available.

Table 4 - An overview of relevant regulations for DG

Current policies and policy goals

The widespread integration of RES and DG will contribute significantly to achieving a wide range of EU policy objectives:

- ◆ Sustainable development, combating climate change and reducing air pollution – e.g. a shift from the large-scale combustion of fossil fuels to a more sustainable, decentralised energy supply will help the EU to meet its Kyoto commitments regarding the emission of greenhouse gases (particularly CO₂) of 8% reduction by 2008-2012.
- ◆ Security and diversity of energy supply – reducing the EU's external energy dependence is crucial for the development of a dynamic and sustainable economy in Europe. If nothing is done, external dependence (on coal, oil and gas) will reach 70% in 20-30 years time, against the current 50%.
- ◆ Increasing the penetration of Renewable Energy Sources – doubling their share in the energy supply quota from 6 to 12% and raising their part in electricity production from 14 to 22% is an objective to be attained by 2010.
- ◆ Energy market liberalisation – the single EU energy markets will change the production, distribution and supply of energy to the benefit of society.
- ◆ Industrial competitiveness – developing and improving solutions for the integration of renewables and distributed generation will create new markets and business opportunities, especially for SMEs. The export potential for such technologies is particularly high in a rapidly growing world energy market, the largest geographical portion of which is devoid of transmission and distribution networks.
- ◆ Economic and social cohesion – remote regions and island communities will benefit greatly from the possibilities offered by the development of decentralised energy technologies. Employment, for example in the agricultural biomass sector, will also be stimulated.

Quite apart from all of these political drivers, there are also sound technical and economic reasons for promoting the integration of RES and distributed generation (DG). For example:

- ◆ Local generation reduces energy transmission losses, helps to avoid congested areas in the existing transmission grids and enables the use of by-product heat, thus improving overall system efficiencies. Power quality and reliability can also be enhanced.
- ◆ RES and DG can be brought on-line much more quickly. Capital exposure and risk is reduced and unnecessary capital expenditure avoided by closely matching capacity increases to local demand growth.

EU directives regarding integration and interconnection

The support of renewable energy sources is one of the key issues in European energy policy. One of the most relevant milestones was established in September 2001 with the adoption of the Directive on the promotion of electricity produced from renewable energy sources in the Internal Electricity Market (RES Directive). Included in this Directive are indicative targets, which have resulted in the distribution of the global EU goal (22% renewable electricity supply in 2010) over the individual Member States, as well as the recommendation to Member States to take appropriate measures to achieve them.

Costs and charges

Description of investment costs of integration and interconnection

The main cost elements for the production of RES are investment costs, operational costs, balancing costs and grid costs. For RES, the owner of the production device has traditionally only been accountable for the investment cost, the operational cost and perhaps part of the costs of connecting the device to the grid.

Integration and interconnection

	Wind generators land-based	Wind generators off-shore	PV	Micro-turbines	Fuel cells	Stirling engines	Recipro-cating engines	Steam cycle
Size kW	10-3000	3000-6000	<1-100	25-500	5-3000	2-500	50-25000+	1000-2000
Installed costs, euro/kW	950-1500	1100-1650	6000-100000	1000-1800	1000-2000	~1800	250-1500	1000-2000
Operations and maintenance costs euro/kWh	0.008	0.01	Little	0.008-0.015	0.005-0.01	0.018	0.005-0.015	0.005
Emissions	No	No	No	Low	Almost no	Low	Fairly low	Fairly low
Availability on demand	Low	Low	Low	High	High	High	High	High
Location	Energy-based	Energy-based	Energy or customer-based	Customer-based	Customer-based	Customer-based	Customer-based	Customer-based
Commercial status	Available, well established	Available, well established	Available	Available, start of commercial application	2005	Available, newly introduced	Available, well established	Available, well established
Application	Green power, remote locations	Green power, remote locations	Green power, base load	Back-up, peak reduction, cogen	Power quality base load	Back-up, peak reduction, cogen	Back-up, peak reduction, cogen	Cogeneration
Fuel	-	-	-	Natural gas	Natural gas	Any heat source	Natural gas, diesel, biofuel	Natural gas, diesel, biofuel

Table 5 - An overview of different DG technologies

Integration and interconnection

Balancing costs, which are particularly significant when it comes to wind energy, have been borne by 'the system'. The costs borne by the RES owner have traditionally been compensated with a subsidy and a fixed electricity price (feed-in-tariff), independent of the real market value of electricity. Therefore, the investment decisions of a RES investor are not related to the actual value of electricity in the given location.

Tariffs

The main barrier to investment in Distributed Generation projects is the cost and potential profitability. All other barriers, whether technical or regulatory, can be translated into cost.

Cost barriers can disproportionately affect small operators because often no differentiation is made between the interconnection requirements of large and small plants. In some regions the connection fees are too high relative to the amount of electricity produced. There is also a need for low cost standardised equipment; for example, islanding protection can cost 350€/kW or more. Moreover, the metering charges levied by grid operators are often excessive with respect to production.

The uplift tariff is the rate the DG producer pays to the distribution utility for transmitting his energy.

Feed-in tariff is the amount the DG operator is paid for energy. At present, these tariffs are set at a level that is expected to encourage investment, but investors must take a view on the long-term movement of these tariffs.

Taxes and incentives

Country specific measures are not discussed in this document.

Fiscal measures

Fiscal measures can be used in different ways for supporting renewable energy. Firstly, the investment can be stimulated by some special fiscal measures (e.g. subsidy, VAT reduction). Secondly, producers or consumers can get a tax exemption if they produce or use renewable energy. This is normally based on an exemption per kWh.

Green pricing

If enough consumers are willing to pay a higher price for energy from RES, a support scheme is not necessary. This is called 'green pricing' and is an option offered by electricity providers (utilities, brokers and stand-alone producers) that allows their customers to support investment in renewable energy technologies. Through green pricing, participating customers pay a premium on their electricity bill to cover the extra cost of the renewable energy.

Conclusion

Integration and interconnection of DG into the existing electricity system is complex involving technical challenges of power quality and protection, operational challenges of load balancing, regulatory challenges of managing fair access and policy challenges of encouraging individual actions to achieve the goals of society. However, the benefits of DG, such as the ability to make use of RES, many of which are naturally dispersed, makes it essential that widespread adoption is achieved in the relatively short term future.

Bibliography

- European Wind Energy Association, <http://www.ewea.org/index.php?id=11>*
- European Transmission System Operators, <http://www.etso-net.org>*
- Union for Co-ordination of Transmission of Electricity, <http://www.ucte.org>*
- Eltra: transmission system operator in Denmark, <http://www.eltra.dk/composite-11286.htm>*
- 'Ondersteuning in EU-project DO en netinvesteringen', KEMA*
- 'Cluster Integration of RES and DG', www.clusterintegration.org*
- European Network for the Integration of Renewables and Distributed Generation, www.dgnet.org*
- International Council on Large Electric Systems, www.cigre.org*
- Transmission and Distribution World, http://tdworld.com/mag/power_impact_dg_reliability/index.html*
- European Commission Energy Research, http://europa.eu.int/comm/research/energy/nn/nn_rt/article_1075_en.htm*
- Enegieonderzoek Centrum Nederland, <http://www.ecn.nl/docs/library/report/2003/rx03023.pdf>*
- Enegieonderzoek Centrum Nederland, <http://www.ecn.nl/docs/library/report/2006/c06017.pdf>*
- Enegieonderzoek Centrum Nederland, <http://www.ecn.nl/docs/library/report/2005/rx05173.pdf>*
- Electric Power Systems Research, http://paginas.fe.up.pt/~cdm/DE2/DG_definition.pdf*
- European Transmission System Operators, <http://www.etso-net.org/upload/documents/ETSORReport%20onRES.pdf>*
- Helsinki University of Technology, Power Systems and High Voltage Engineering, http://powersystems.tkk.fi/nordac2004/papers/nordac2004_kauhaniemi_et_al_paper.pdf*
- Enegieonderzoek Centrum Nederland, http://www.ecn.nl/_files/wind/documents/Tilaran02_GridImpCR.pdf*
- 'Small is beautiful',: Roald A A de Graaff, J H R Enslin, KEMA*
- White Paper for a Community Strategy and Action Plan, <http://www.managenergy.net/products/R26.htm>.*

Reference & Founding* Partners

European Copper Institute* (ECI) <i>www.eurocopper.org</i>	EPRI Solutions Inc <i>www.epri.com/eprisolutions</i>	Laborelec <i>www.laborelec.com</i>
ABB Power Quality Products <i>www.abb.com</i>	ETSII - Universidad Politécnica de Madrid <i>www.etsii.upm.es</i>	MGE UPS Systems <i>www.mgeups.com</i>
Akademia Gornicz-Hutnicza (AGH) <i>www.agh.edu.pl</i>	Fluke Europe <i>www.fluke.com</i>	Otto-von-Guericke-Universität Magdeburg <i>www.uni-magdeburg.de</i>
Centre d'Innovació Tecnològica en Convertidors Estàtics i Accionaments (CITCEA-UPC) <i>www.citcea.upc.edu</i>	Hochschule für Technik und Wirtschaft* (HTW) <i>www.htw-saarland.de</i>	Polish Copper Promotion Centre* (PCPC) <i>www.miedz.org.pl</i>
Comitato Elettrotecnico Italiano (CEI) <i>www.ceiuni.it</i>	Hogeschool West-Vlaanderen Departement PIH <i>www.pih.be</i>	Socomec Sicon UPS <i>www.socomec.com</i>
Copper Benelux* <i>www.copperbenelux.org</i>	International Union for Electricity Applications (UIE) <i>www.uie.org</i>	Università di Bergamo* <i>www.unibg.it</i>
Copper Development Association* (CDA UK) <i>www.cda.org.uk</i>	ISR - Universidade de Coimbra <i>www.isr.uc.pt</i>	University of Bath <i>www.bath.ac.uk</i>
Deutsches Kupferinstitut* (DKI) <i>www.kupferinstitut.de</i>	Istituto Italiano del Rame* (IIR) <i>www.iir.it</i>	The University of Manchester <i>www.manchester.ac.uk</i>
Engineering Consulting & Design* (ECD) <i>www.ecd.it</i>	Katholieke Universiteit Leuven* (KU Leuven) <i>www.kuleuven.ac.be</i>	Wroclaw University of Technology* <i>www.pwr.wroc.pl</i>

Editorial Board

David Chapman (Chief Editor)	CDA UK	david.chapman@copperdev.co.uk
Prof Angelo Baggini	Università di Bergamo	angelo.baggini@unibg.it
Dr Araceli Hernández Bayo	ETSII - Universidad Politécnica de Madrid	ahernandez@etsii.upm.es
Prof Ronnie Belmans	UIE	ronnie.belmans@esat.kuleuven.ac.be
Dr Franco Bua	ECD	franco.bua@ecd.it
Jean-Francois Christin	MGE UPS Systems	jean-francois.christin@mgeups.com
Prof Anibal de Almeida	ISR - Universidade de Coimbra	adealmeida@isr.uc.pt
Hans De Keulenaer	ECI	hdk@eurocopper.org
Prof Jan Desmet	Hogeschool West-Vlaanderen	jan.desmet@howest.be
Dr ir Marcel Didden	Laborelec	marcel.didden@laborelec.com
Dr Johan Driesen	KU Leuven	johan.driesen@esat.kuleuven.ac.be
Stefan Fassbinder	DKI	sfassbinder@kupferinstitut.de
Prof Zbigniew Hanzelka	Akademia Gornicz-Hutnicza	hanzel@uci.agh.edu.pl
Stephanie Horton	ERA Technology	stephanie.horton@era.co.uk
Dr Antoni Klajn	Wroclaw University of Technology	antoni.klajn@pwr.wroc.pl
Kees Kokee	Fluke Europe BV	kees.kokee@fluke.nl
Prof Dr rer nat Wolfgang Langguth	HTW	wlang@htw-saarland.de
Prof Henryk Markiewicz	Wroclaw University of Technology	henryk.markiewicz@pwr.wroc.pl
Carlo Masetti	CEI	masetti@ceiuni.it
Mark McGranaghan	EPRI Solutions	mmcgranaghan@eprisolutions.com
Dr Jovica Milanovic	The University of Manchester	jovica.milanovic@manchester.ac.uk
Dr Miles Redfern	University of Bath	eesmar@bath.ac.uk
Dr ir Tom Sels	KU Leuven	tom.sels@esat.kuleuven.ac.be
Prof Dr-Ing Zbigniew Styczynski	Universität Magdeburg	Sty@E-Technik.Uni-Magdeburg.de
Andreas Sumper	CITCEA-UPC	sumper@citcea.upc.edu
Roman Targosz	PCPC	cem@miedz.org.pl
Dr Ahmed Zobaa	Cairo University	azmailinglist@link.net



Jan Bloem



KEMA Nederland B.V.
Utrechtseweg 310
6812 AR Arnhem
The Netherlands

Tel: 00 31 26 3 56 91 11
Email: jan.bloem@kema.com
Web: www.kema.com

Copper Development Association

Copper Development Association
5 Grovelands Business Centre
Boundary Way
Hemel Hempstead
HP2 7TE

Fax: 00 44 1442 275716
Email: helpline@copperdev.co.uk
Websites: www.cda.org.uk and www.brass.org



European Copper Institute
168 Avenue de Tervueren
B-1150 Brussels
Belgium

Tel: 00 32 2 777 70 70
Fax: 00 32 2 777 70 79
Email: eci@eurocopper.org
Website: www.eurocopper.org