

Power Quality Application Guide



Earthing & EMC

Fundamentals of Electromagnetic Compatibility (EMC)

6.1.2

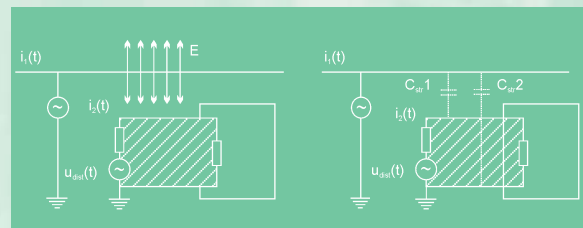
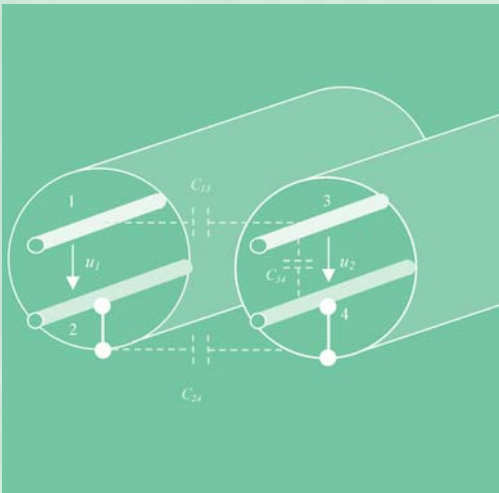

Earthing & EMC

Fundamentals of Electromagnetic Compatibility (EMC)

Prof Dr rer nat Wolfgang Langguth
Hochschule für Technik und Wirtschaft

May 2006



This Guide has been produced as part of the Leonardo Power Quality Initiative (LPQI), a European education and training programme supported by the European Commission (under the Leonardo da Vinci Programme) and International Copper Association. For further information on LPQI visit www.lpqi.org.



Copper Development Association (CDA)

Copper Development Association is a non-trading organisation sponsored by the copper producers and fabricators to encourage the use of copper and copper alloys and to promote their correct and efficient application. Its services, which include the provision of technical advice and information, are available to those interested in the utilisation of copper in all its aspects. The Association also provides a link between research and the user industries and maintains close contact with the other copper development organisations throughout the world.

CDA is an IET endorsed provider of seminar training and learning resources.



European Copper Institute (ECI)

The European Copper Institute is a joint venture between ICA (International Copper Association) and the European fabricating industry. Through its membership, ECI acts on behalf of the world's largest copper producers and Europe's leading fabricators to promote copper in Europe. Formed in January 1996, ECI is supported by a network of eleven Copper Development Associations ('CDAs') in Benelux, France, Germany, Greece, Hungary, Italy, Poland, Russia, Scandinavia, Spain and the UK.

Disclaimer

The content of this project does not necessarily reflect the position of the European Community, nor does it involve any responsibility on the part of the European Community.

European Copper Institute, Hochschule für Technik und Wirtschaft and Copper Development Association disclaim liability for any direct, indirect, consequential or incidental damages that may result from the use of the information, or from the inability to use the information or data contained within this publication.

Copyright© European Copper Institute, Hochschule für Technik und Wirtschaft and Copper Development Association.

Reproduction is authorised providing the material is unabridged and the source is acknowledged.

LPQI is promoted in the UK by members of the Power Quality Partnership:



Fundamentals of Electromagnetic Compatibility (EMC)

Introduction

In the past the majority of appliances used in the electrical installations of conventional buildings were linear loads (such as ac-dc-motors, resistive loads, filament lamps etc.), which lead to no, or very little, interference between different items of equipment. Now many of the loads in use are non-linear (inverter driven ac-motors, discharge lamps, energy saving lamps etc.). These produce narrow band noise (due to devices switching at fixed frequencies above 9 kHz) which can spread all over the network. Typically Switch-Mode Power Supplies produce this type of conducted interference signal (operating in the range of 10 kHz to 100 kHz). At the same time, an increase in the use of digital systems can be observed, such as IT equipment for technical facility management and for industrial process automation systems, multimedia applications and business use.

On one hand, power supply systems are becoming more powerful, which can lead to electromagnetic interference (EMI); on the other hand digital networks are expanding, becoming more sensitive, performing at higher data transfer rates and are increasingly used for safety related tasks. This development demands high quality electrical installations in all buildings where electromagnetic non-compatibility leads to either higher costs or to an unacceptable decrease in safety standards.

Basically all electrical conductive components of buildings and facilities play a role in electromagnetic interference either as a source (EMI transmitter) or as a drain (EMI receiver). Besides the installed electrical conductors there are metal pipelines, reinforcement bars in concrete, metal facades and constructional steel work, which may also become part of the EMC-relevant installation and transmit EMI as well. It often appears that any installation may act as a source and a drain simultaneously. Typical systems are:

- ◆ Power supply lines
- ◆ Measurement and control devices
- ◆ Alarm devices
- ◆ Computer installations, including networks.

An inadequate installation, together with a TN-C installation, allows noise signals to spread over the entire building and even to reach neighbouring buildings of the facility.

The increasing importance of EMC has been realised by the European Community. According to the EMC directive of the EU 89/336/EEC (amended by directives 91/263/EEC, 92/31/EEC, 93/68/EEC and 93/97/EEC) any electrical installation of buildings has to also respect the international standards for EMC susceptibility and emission. The person or persons responsible for design, engineering and construction (assembly and erection) becomes the 'manufacturer' in the sense of the directive and assumes full responsibility for the installation's compliance with all applicable provisions of the directive when put into service.

To implement a reliable and cost-effective EMC-safe electrical installation in a building, it is absolutely necessary to perform an EMC-analysis and develop an EMC-plan at a very early planning stage in the project. All electrical installations should be required to be supervised and implemented by EMC-trained personnel.

The aim of this Section is to give an overview and a basic understanding of the major physical principles of electromagnetic interference and an introduction to the principles of mitigation of disturbing effects. As a result, the measures required to achieve an EMC-compliant installation should be easily understood.

Fields as the fundamental source of electromagnetic interference

Electromagnetic compatibility (EMC) describes the ability of any electrical or electronic system, machine, appliance etc. to operate without malfunction in a disturbing electromagnetic environment while not itself disturbing the operation of other components of the system.

Fundamentals of Electromagnetic Compatibility (EMC)

The fundamental sources of any electromagnetic interference (EMI) are the basic fields and currents of electrodynamics. At low frequencies the electric and magnetic fields act independently; at high frequencies only the propagating electromagnetic field is of importance.

All fields at low, medium and high frequency are generated by electric charges and currents. At low frequencies the electric and the magnetic fields are relatively short-ranged, falling off in intensity from their source at least inversely proportional with distance, and are therefore concentrated in the vicinity of the lines of the conductor that might carry some current or voltage.

Since the electric field is proportional to the voltage of the electrical installation, it will only be of sufficient strength to cause EMI effects at large distances in the vicinity of high voltage installations. In most installations, however, electric fields do not play a major role. However, at short distances, as in the case of cables that run together in cable trunks, the electric field has to be considered as a source of possible EMI.

The magnetic field is proportional to the strength of the electrical current. In many power supply systems currents may reach rather high values, so magnetic fields may become strong and the danger of EMI effects is great. This is particularly likely in a TN-C-type installation. Due to the combination of the neutral (N) conductor and the protective earth (PE) conductor into a PEN conductor, and the consequent connections to other conducting parts of the building, the currents may reach every region of the building and the resulting magnetic fields may cause EMI effects almost everywhere. Since part of the neutral return current is flowing in extraneous metal parts, the current sum in the TN-C-network itself is unbalanced and the net magnetic field of the TN-C-network is increased by orders of magnitude.

Cathode ray tube-type computer terminals are easily disturbed (flickering on the screen) by magnetic fields of the order of 1.5 μ T. Such a field can be generated by a single power line carrying a 10 A 50 Hz current within a distance of 1.3 m. Larger cathode ray tube computer terminals (>17 inch) are even more sensitive to external magnetic fields. If the power line currents have higher frequency components, the magnetic fields will have even more pronounced effects.

At high frequencies the electric and magnetic fields combine to form the electromagnetic field, which travels through space with the velocity of light. Consequently, there is potential for disturbance at much greater distances. Typical sources of electromagnetic fields nowadays are radar, radio and TV transmitters, mobile phones, DECT telephones, wireless networks (WLAN), Bluetooth[®] links and industrial installations in the microwave frequency range. However, power cables may act as antennas and propagate any high frequency signals that are intentionally (e.g. power line communication) or unintentionally (e.g. fast transients) present on the network. To immunise electrical installations against electromagnetic fields, careful design and installation of shielding measures have to be carried out.

Types of electromagnetic couplings

Elementary coupling model of EMI

To describe the mechanism of electromagnetic interference it is easiest to start with a very simple model. It consists of a source, which causes the interference, a coupling mechanism or coupling media and the disturbed device.

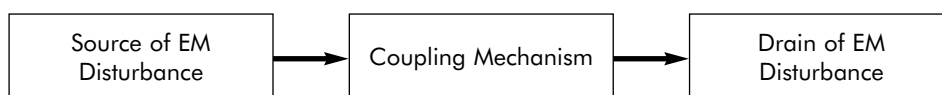

Figure 1- Elementary coupling model of EMI

Examples of sources may, as mentioned above, be lines of the electrical power system, antennas of wireless LAN systems, etc. The coupling is established via the current if common conductors by different circuits are shared by the electric, magnetic or electromagnetic fields. The disturbed drains may be any kind of apparatus or any parts of the electrical installation. Of course, the complete electromagnetic interaction of

all installations in a building or facility is a very complex combination of these elementary interactions. Additionally, any drain may also act as a source of EMI, and vice versa.

During the planning phase of a new or refurbished installation a matrix of all possible sources, coupling paths and possible disturbed objects should be generated. With the aid of this matrix the possible strength of mutual interference must be estimated to judge which EMI disturbances may occur and which are likely to be relevant. Only on the basis of this EMI interaction matrix can counter-measures be planned at the start, ensuring rapid and cost-effective commissioning.

Four different types of elementary EMI can be identified:

- ◆ Impedance coupling
- ◆ Inductive coupling
- ◆ Capacitive coupling
- ◆ Radiative coupling.

The basic physical properties of the different coupling methods are summarised in the following table:

Source	Frequency domain	Coupling	Range	Drains
Electric field	Low frequency	Capacitive	Short	High and low voltage cables
Magnetic field	Low frequency	Inductive	Short	High and low voltage cables
Electromagnetic field	High frequency	Radiative	Long	High and low voltage cables

Table 1 - Elementary properties of EMI coupling types

The dominant disturbing phenomena in buildings are due to the inductive coupling, followed by capacitive and impedance coupling. The radiative coupling in general has not been dominant until now, since the field strengths are usually well below the required limiting values for susceptibility tests of the EU-directive for EMC. However, the increasing use of wireless applications may lead to an increase in EMI phenomena from this source in the future.

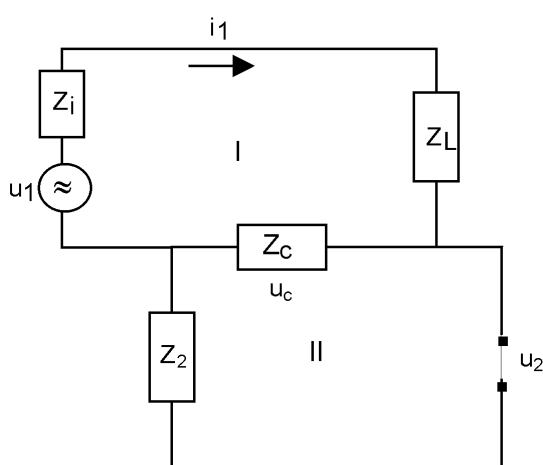

Figure 2 - Impedance coupling

Impedance coupling

Galvanic coupling occurs when different circuits use common lines and/or coupling impedances. This may happen, for example, when different circuits use the same voltage source in their circuit. The underlying principle of the impedance coupling can be readily seen in Figure 2.

Circuit I may be part of a power supply network and circuit II part of a data transfer network. The voltage, which is superimposed on the signal u_2 due to the common coupling impedance $Z_c = R_c + j\omega L_c$ is for small $Z_c \ll Z_i + Z_L$ given by:

$$u_c = Z_c \cdot i_1 \approx \frac{u_1}{Z_i + Z_L} Z_c \quad (1)$$

If the current i_1 and/or the coupling impedance Z_c are large enough, the superimposed voltage u_k may be large enough compared to the signal u_2 to disturb the data circuit.

The impedance of the shared line consists of resistive and inductive components, $Z_c(\omega) = R_c + j\omega L_c$. While the resistive part of the coupling remains of the same importance for all frequencies (neglecting skin effect), the inductive part becomes of increasing importance at high frequencies. For a short discussion we look at the following model:

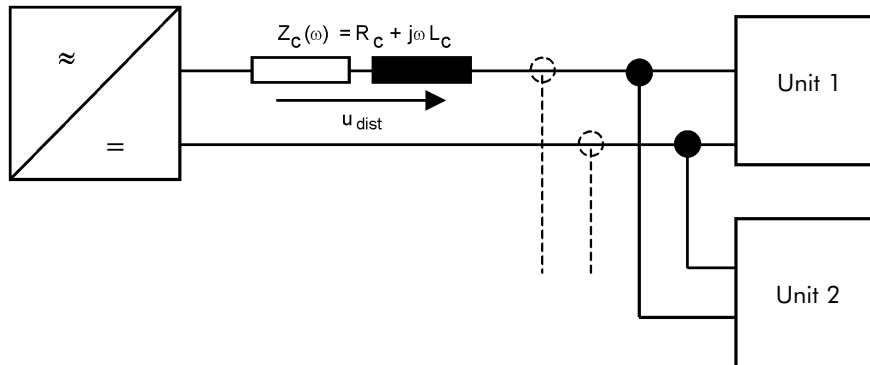

Figure 3 - Impedance coupling, simple model

The disturbing voltage u_{dist} , developed across Z_c , is superimposed on the signal of unit 2 and depends on the current $i(t)$ and also on its time variation $di(t)/dt$. In a simplified model the disturbing voltage may be estimated by:

$$u_{dist} = u_{R,dist} + u_{L,dist} = R_c \cdot i(t) + L_c \cdot \frac{di(t)}{dt} \quad (2)$$

If we choose a set of realistic parameters for our model: (line length of $l=2\text{ m}$, self-inductance of $L_c=1\mu\text{H/m}$, resistance of $R_c=1\Omega$, current $i=1\text{A}$ and a rate of change of current $di/dt=1\text{A}/100\text{ ns}$), we get the following contributions for the galvanic coupling:

$$\begin{aligned} u_{R,dist} &= R_c \cdot i(t) = 1\text{V} \\ u_{L,dist} &= L_c \cdot \frac{di(t)}{dt} = 20\text{V} \\ u_{dist} &= u_{R,dist} + u_{L,dist} = 21\text{V} \end{aligned} \quad (3)$$

At high frequencies the self-inductance of the lines clearly plays the dominant role. This remains true even if we take into account the increasing apparent resistance of the line due to the skin effect, which is not negligible for fast transients and digital signals.

Following Kirchhoff's laws, the disturbing signals may spread over the installation of an entire facility and may even affect the installations of neighbouring facilities. To minimise the galvanic coupling it is necessary to avoid connections between independent systems and, in cases where connections are necessary, to keep their self-inductance as low as possible. Generally galvanic decoupling of electrical power supply circuits can be achieved more easily when a TN-S system is used rather than a TN-C system.

Inductive coupling

A time varying external current $i_1(t)$ generates a magnetic field $B(t)$, which induces a disturbing voltage $u_{dist}(t)$ in a neighbouring circuit. In an equivalent circuit model this may be described by a coupling of both circuits via a coupling inductance M . The voltage $u_{dist}(t)$ generates a common mode current $i_2(t)$, which itself generates a magnetic field to weaken the external field. The current $i_2(t)$ is superimposed on the currents of the disturbed system and may lead to malfunctions of the system. The coupling of magnetic fields of the different systems can be modelled by an equivalent circuit model by mutual inductances of the coupled circuits (Figure 4).

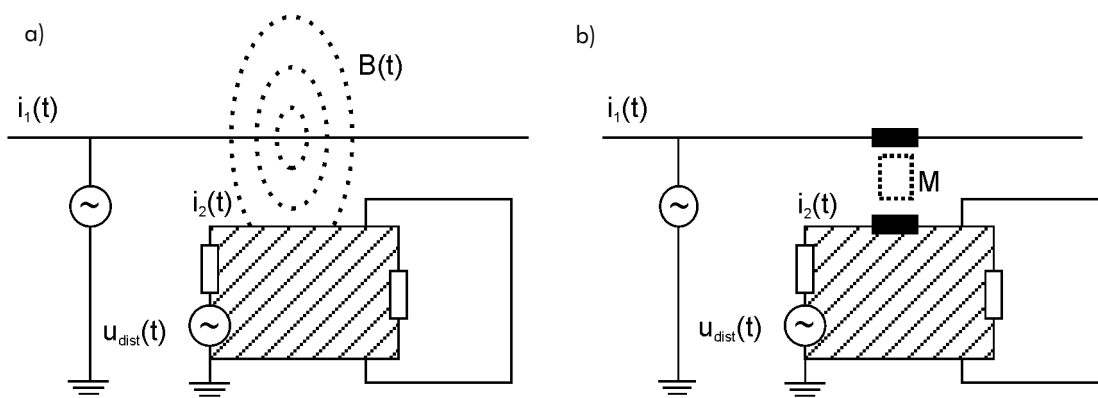

Figure 4 - Inductive coupling a) field model, b) equivalent circuit

The strength of the coupling depends mainly on three parameters:

- ◆ the strength of the disturbing current
- ◆ the distance of source and drain
- ◆ the frequency of the disturbing field.

The disturbing signal becomes large and significant if:

- ◆ the currents of the external circuits are large
- ◆ the currents of a go-and-return line are unbalanced (as in a TN-C-network)
- ◆ the circuits are close together and cover a large area
- ◆ the signals of the external circuit vary rapidly in time and therefore have a large high frequency content.

Inductive coupling, however, may also be useful in controlling disturbance. If the installation of cable trays and coaxial cables is done properly, (i.e. they are reliably connected with short connections with a low impedance also at high frequencies) they provide shielding of the cables (via inductive coupling) against external magnetic fields, especially at higher frequencies.

Geometric dependence of the inductive coupling

The sensitivity of inductive coupling to electrical network type and the geometry of the installation can be demonstrated by the following example. The conclusions are important for EMC compatible installations.

We consider two circuits, a single line and a go-and-return line, and calculate the influence of both systems on a circuit, modelled by a rectangular loop at a distance, r .

The magnetic field of each configuration can be calculated exactly:

$$B_1(r) = \frac{\mu_0}{2\pi} \cdot \frac{i(t)}{r}, \quad B_2(r) = \frac{\mu_0}{2\pi} \cdot \frac{2a \cdot i(t)}{(r-a)(r+a)}, \quad \text{where } \mu_0 = 4\pi \cdot 10^{-7} \left[\frac{Vs}{Am} \right] \quad (4)$$

The magnetic field is proportional to the current $i(t)$. However, while the field of the single line decreases only inversely proportional to the distance, the field of the go-and-return line decreases inversely proportional to *the square* of the distance at large distances. This leads to a dramatically different distance dependence of the inductive coupling for each network model. This behaviour for the magnetic field and for the inductive coupling per unit length is shown in the next figure. The current $i(t)$ is chosen to be of $1A$ and the distance $a = 1.5\text{ mm}$.

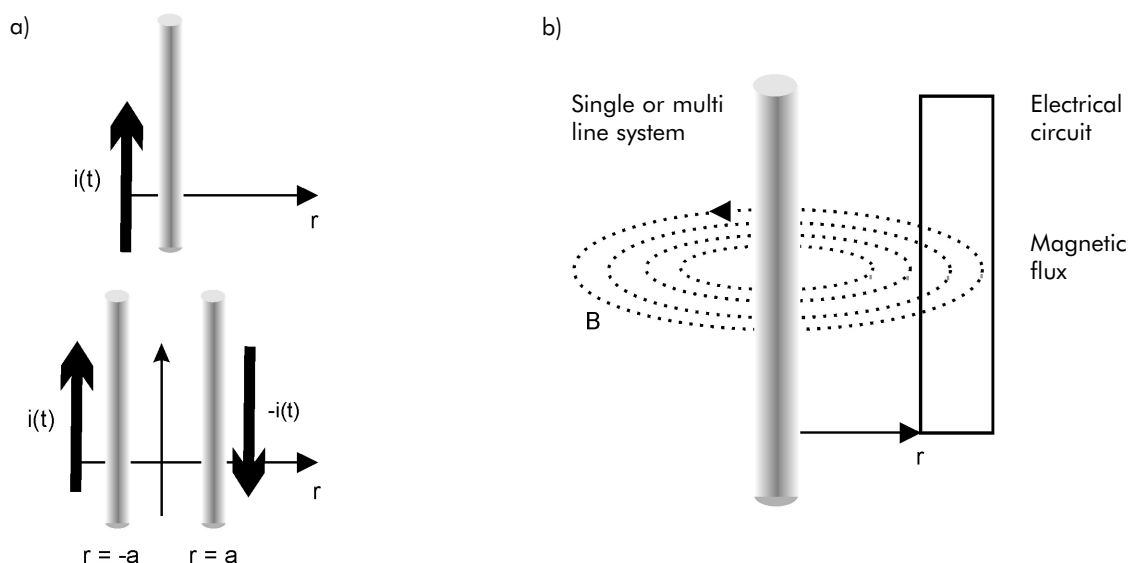

Figure 5 - a) A single and a go-and-return line as sources of a magnetic field
b) an electrical circuit as a drain

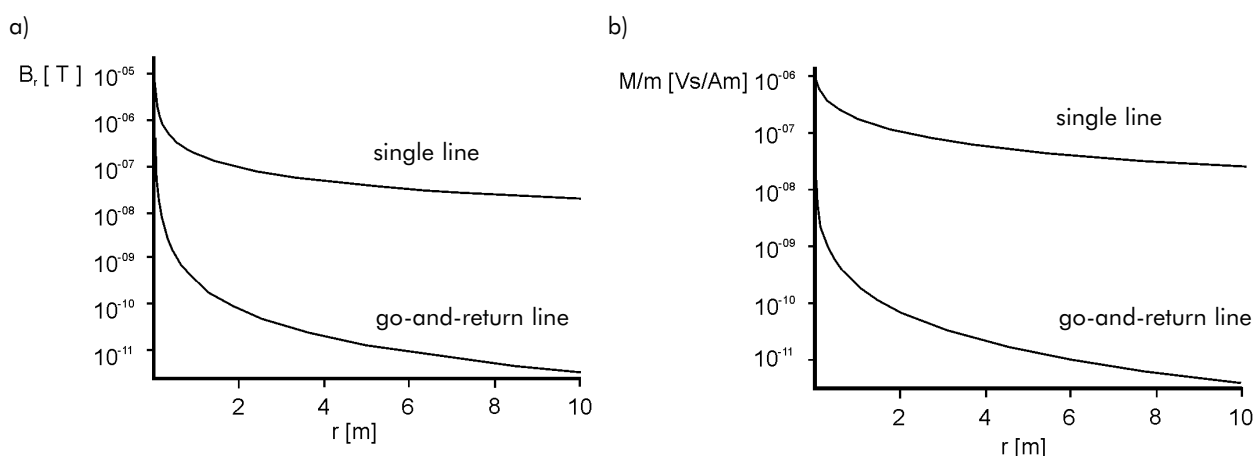

Figure 6 - a) the magnetic field of a single and a go-and-return line
b) the coupling inductance per unit length of a loop to a single and a go-and-return.

The magnetic field of the balanced go-and-return line is two orders of magnitude smaller and drops off faster than that of the single line. The same is true for the coupling inductance. The dependence of the coupling inductance on the area of the loop is quite similar to Figure 6b). This example provides the most elementary background knowledge for some 'golden rules' for an EMC compliant electrical installation:

- ◆ keep the area of any electrical installation as small as possible
- ◆ maximise the distance to lines with high currents
- ◆ separate power lines from data lines
- ◆ use TN-S-type networks only.

Only TN-S networks are EMC-friendly. In TN-C networks unbalanced currents may arise, so that the TN-C network generates the magnetic field of a single line carrying the unbalanced current. For the same installation geometry the unbalanced current generates a magnetic field of at least two orders of magnitude higher than of a TN-S network.

Frequency dependence of the inductive coupling

The frequency behaviour of the inductive coupling provides valuable knowledge about how an electrical installation can be implemented to achieve optimal protection against external high frequency disturbances. We consider again an idealised experimental set-up similar to Figure 5b). Figure 7 shows the equivalent circuit of a short loop of self-inductance L_2 and resistance R_2 which is influenced by an external line carrying a current $i_1(t)$ with a coupling inductance M .

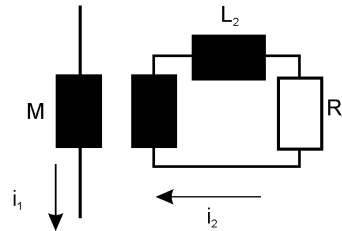

Figure 7 - Equivalent circuit for the inductive coupling

If we consider currents of a defined frequency ω , $i_{1,2}(t) = i_{1,2}(\omega)e^{j\omega t}$, the transfer function of the disturbing current $i_1(\omega)$ and the induced current $i_2(\omega)$ for the simple model can be calculated exactly and yields the transfer function of Equation 5.

$$i_2 = \frac{sM}{R_2 + sL_2} i_1, \quad s = j\omega, \quad j^2 = -1 \quad (5)$$

To get an understanding of what this formula means for a real installation, we consider a loop of a length of $l = 0.3 \text{ m}$ and a width of $w = 0.1 \text{ m}$, which is a distance $d = 2 \text{ mm}$ apart from the disturbing current line. For the internal resistance we choose $R_2 = 50 \text{ } \Omega$. The self-inductance and the mutual inductance can be calculated for this example to be $L_2 = 0.9 \text{ } \mu\text{H}$ and $M = 0.2 \text{ } \mu\text{H}$. The magnitude of the disturbing current per unit of the external current $i_2(\omega)/i_1(\omega)$ is shown in the following figure:

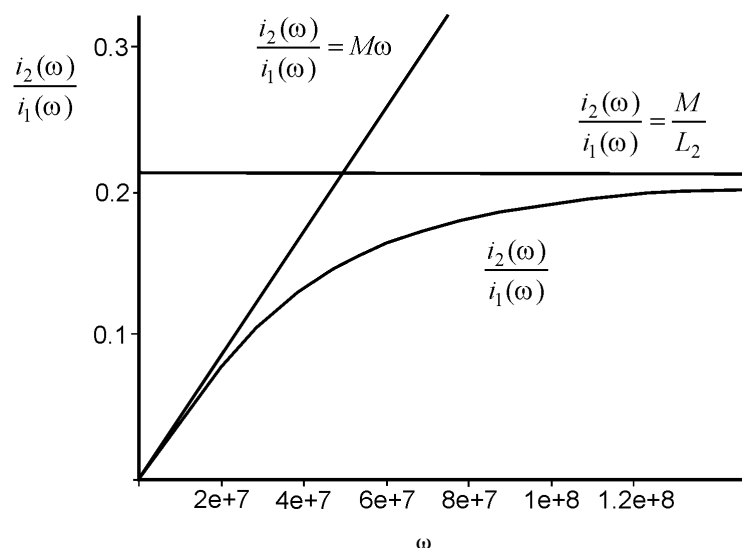

Figure 8 - Case study of the transfer function of the current

The disturbing current i_2 increases with the external current i_1 and its frequency. At low frequencies it increases proportional to ω , while at high frequencies i_2 reaches its saturation value. This saturation value is limited by the ratio M/L_2 . To minimise the EMI effects, an EMC compliant installation must minimise the mutual inductance M and maximise the self inductance L_2 of the coupled circuit.

Since fast disturbances contain more and higher high frequency content, they generate a greater disturbance. This can be seen from Figure 9, where the calculated disturbing current resulting from a trapezoidal current waveform, representing a digital signal, is shown.

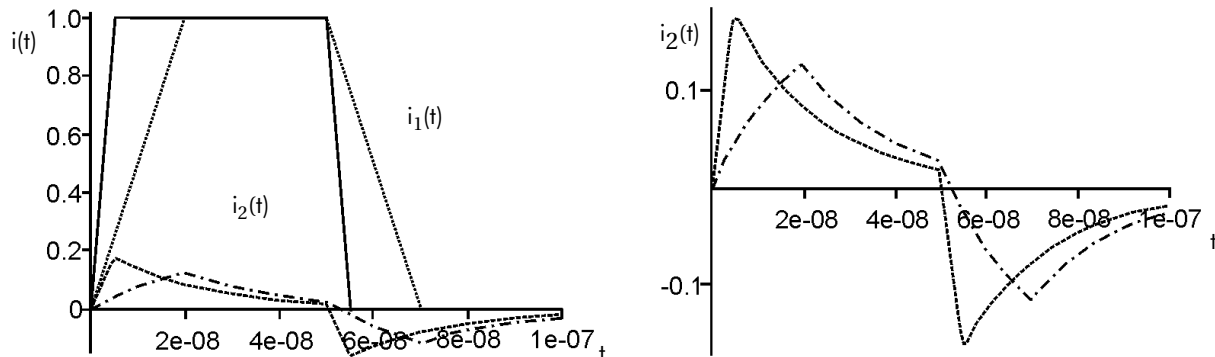

Figure 9 - Inductive coupling of slow and fast trapezoidal currents

It can be seen from Figure 9 that the disturbing current reaches more than 10% of the amplitude of the slow, and more than 15% of the amplitude of the fast, external current. These high values result from the short rise times of the digital signals. Similar high values are to be expected from any electronic switching process such as phase-angle control dimmers. The switching of the dimmer can be modelled by the onset of the trapezoidal signal. The remaining part of the 50 Hz signal only gives a negligible contribution.

So far, we have looked at the short circuit loop as a drain of EMI. In this case, the electrical properties have to be optimised to minimise the disturbing current $i_2(t)$. The property of the induced current $i_2(t)$ to generate a magnetic field that weakens the external field can also be used to shield enclosed sensitive electrical or electronic systems. In this case the electrical parameters of the short circuit loop have to be chosen to optimise the counter field generating current $i_2(t)$ and to minimise the net magnetic flux through the loop. Practical examples of this application are the shield of any shielded cable, cable trays, unused cores of cables etc. The net magnetic flux across the area of our model short circuit loop can be calculated to be:

$$\Phi_{loop}(i_2) = \frac{MR_2}{R_2 + sL_2} i_1, \quad s = j\omega, \quad j^2 = -1 \quad (6)$$

It can be seen that the net magnetic flux is minimised for small values of R_2 . The shielding properties of our model short circuit loop, for various values of R_2 , is shown in Figure 10.

The shielding effectiveness increases drastically with decreasing resistance of the short circuit loop, here shown for values of $R_2 = \infty, 500, 50, 5 \Omega$.

From this result important installation rules in buildings emerge. All connections of shielding facilities like cable trunks, cable channels, cabinets etc. have to be of low resistance at high frequencies. Due to the skin-effect, the resistance of any electric conductor increases with the frequency of the signal. Therefore the geometries of the conductors must be chosen to minimise the apparent resistance at high frequencies. The optimum conductor geometry is flat strip, either solid or braid, where the surface area is large and the thickness is small. Standard circular section conductors are not ideal.

Of course a short circuit loop works only effectively as a shielding device if the protecting current may flow and there is no disconnection in the short circuit loop. Shields have to be connected to ground at both ends to enable an unhindered flow of the shielding current.

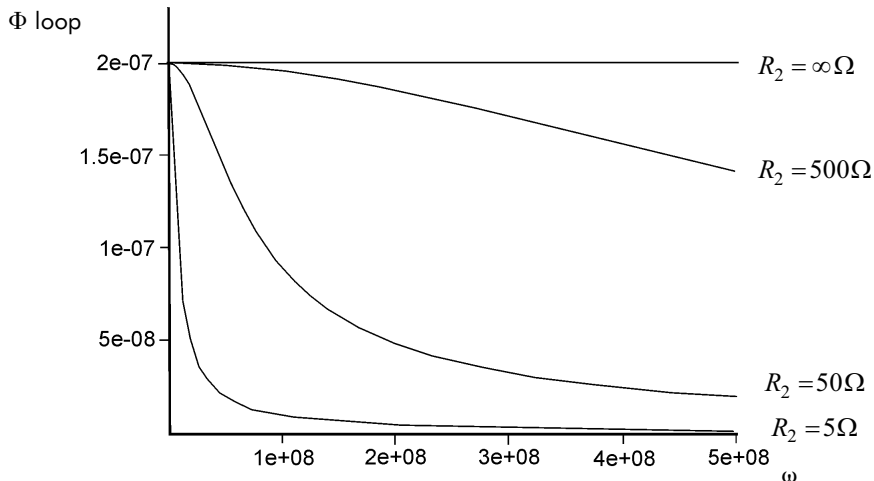

Figure 10 - Shielding effectiveness of a short circuit loop for various values of its resistance R_2

Capacitive coupling

The time varying electrical field of an external system produces time varying charges in the disturbed system. The flow of the displacement currents can be modelled in an equivalent circuit by stray capacitances, which connect the two systems and cause the disturbing voltages.

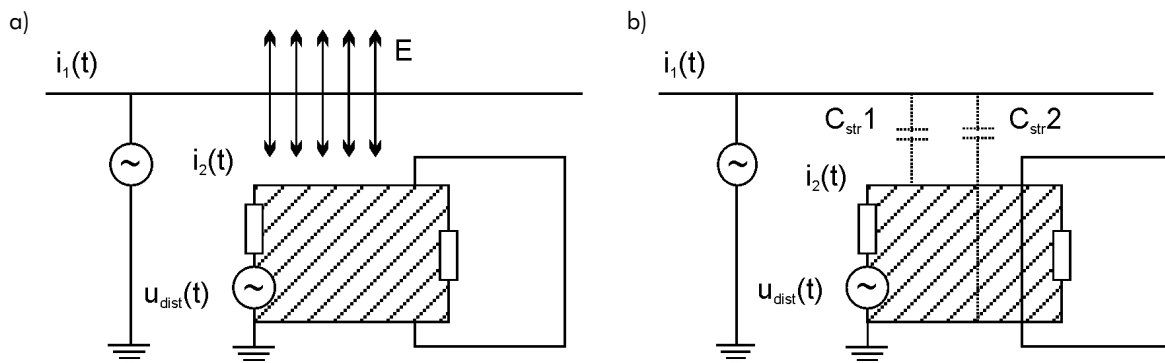

Figure 11 - Capacitive coupling a) field model, b) equivalent circuit

Similar to the case of the inductive coupling, the capacitive coupling becomes large if:

- ◆ the two circuits are close together
- ◆ the voltage difference of the two circuits is large
- ◆ the signals in the external circuit are rapidly varying in time and therefore possess a large high frequency content.

As an example, one may consider the cables of a circuit of a power supply and of a circuit of a local area network, which may lay close to and parallel with each other over a distance of 10 m in a cable tray. If the current in the power cable has a pure sine form at 50 Hz at 230 V, the disturbing signal in the data cable reaches an amplitude of 10 V, which may be acceptable. However, if the current in the power cable possesses high frequency components generated by non-linear loads, the disturbing signal in the data cable may reach an amplitude of more than 90 V, which may lead to poor performance or malfunctions of LANs.

If the cabling and shielding requirements are planned properly, and the installation is carried out carefully, these types of disturbances can be avoided or at least minimised to a tolerable level.

To discuss the most important aspects of capacitive coupling we consider again an elementary model, which can be solved analytically. The model consists of two circuits which use, for simplicity, a common return. The equivalent circuit of the system is shown in the next figure.

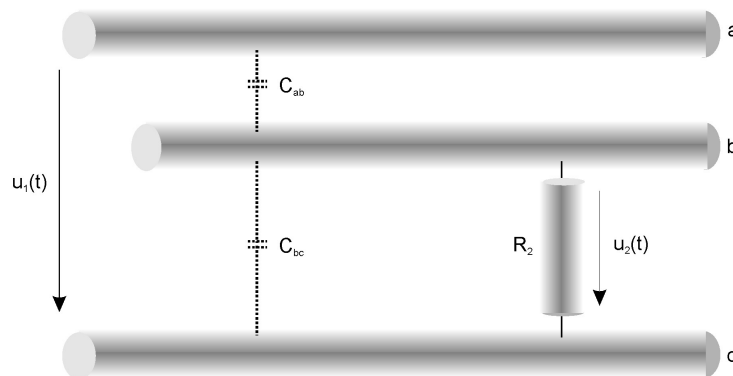

Figure 12 - Three line model for capacitive coupling

The lines a and c are part of the external system, lines b and c of the disturbed system. If we consider voltages of a defined frequency ω , $u_{1,2}(t) = u_{1,2}(\omega)e^{j\omega t}$, the relation between the disturbing voltage $u_1\omega$ and the coupled voltage $u_2\omega$ for this simple model can be calculated exactly:

$$u_2 = \frac{sR_2C_{ab}}{1 + sR_2(C_{ab} + C_{bc})} u_1, \quad s = j\omega, \quad j^2 = -1 \quad (7)$$

We choose for the model parameters $R_2 = 1k\Omega$, $C_{ab} = C_{cb} = 100 \text{ pF}$, which is reasonable for parallel cables of thickness of 1 mm, at a distance of 5 mm over a length of 10 m, and an external voltage of $u_1 = 220 \text{ V}$. The behaviour of the frequency dependence of the capacitive coupled voltage u_2 is shown in Figure 13.

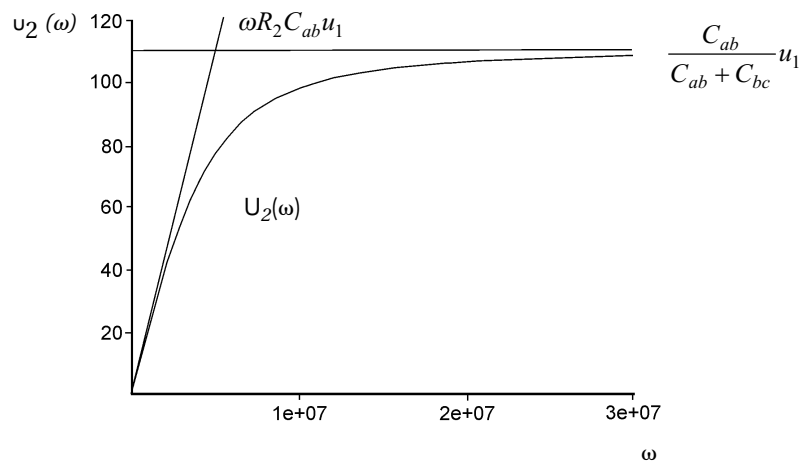

Figure 13 - Frequency behaviour of the capacitive coupling

The behaviour of capacitive coupling is very similar to that of inductive coupling. The disturbing voltage u_2 increases at low frequencies linearly with the frequency of the disturbing signal and reaches a saturation value at high frequencies. Again, fast disturbing signals that contain large high frequency components will influence the disturbed circuit massively. Figure 14 shows the coupled voltage of a normal 220 V sine-wave of 50 Hz and a phase-angle control dimmer.

Fundamentals of Electromagnetic Compatibility (EMC)

The sine-wave produces a sinusoidal disturbing signal with an amplitude of about 7 mV, which in most cases can be neglected. In contrast the switching process of the dimmer leads to a voltage peak of 110 V.

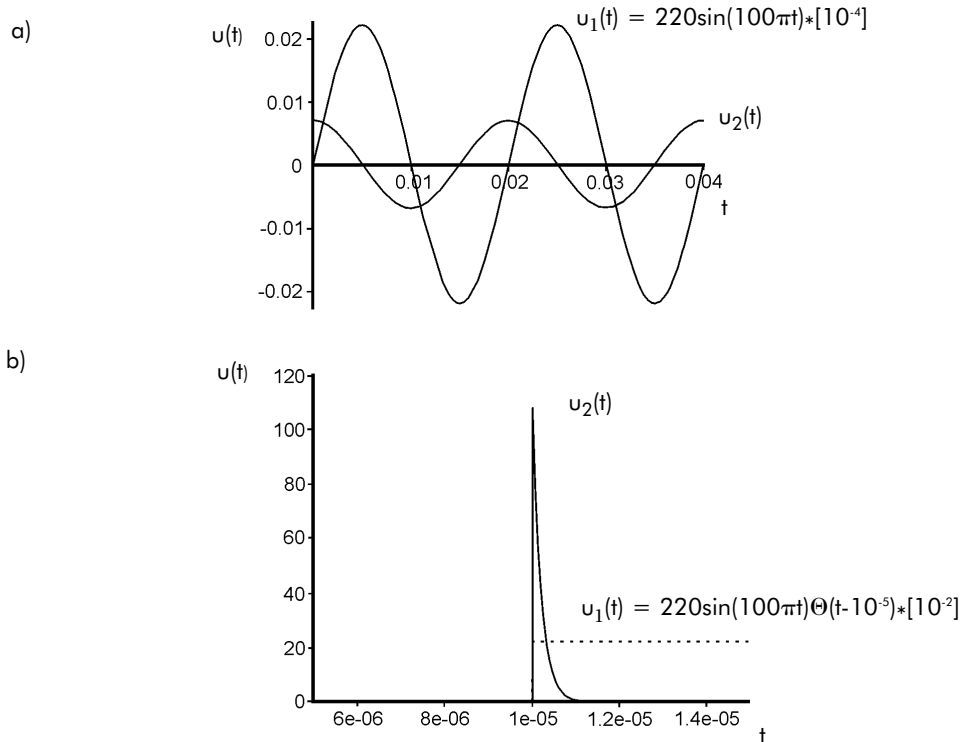

Figure 14 - Capacitive coupled signals of a) a 50 Hz sine wave, b) a phase-angle control dimmer

The capacitive coupling can be reduced using shielded cables. The model of a pair of shielded cables is shown in the next figure.

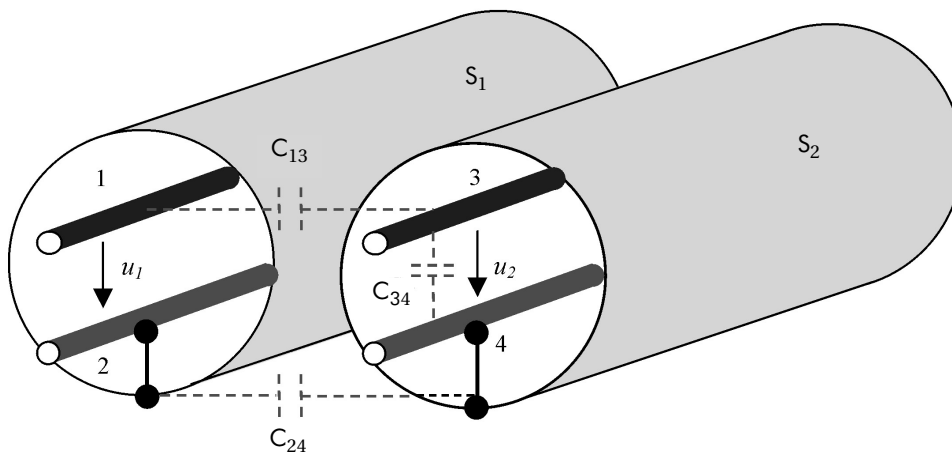

Figure 15 - Capacitive coupling of two shielded cables

The conducting shields S_1 and S_2 are connected at a single point to the system. The frequency behaviour of the disturbed voltage u_2 , is the same as in equation 7, where:

$$C_{ab} \text{ has to be replaced by } C_1 = \frac{C_{13}C_{24}}{C_{13} + C_{24}} \text{ and } C_{bc} \text{ by } C_{34}.$$

The maximal voltage, which might be coupled amounts to $u_2 = \frac{1}{1 + C_{34}/C_{13} + C_{34}/C_{24}} u_1$, which shows that

a good capacitive connection C_{34} between the conductor and the shield improves the effectiveness of the shield. For various capacitive couplings the effectiveness of a shielded cable against a fast transient pulse is shown in the next figure.

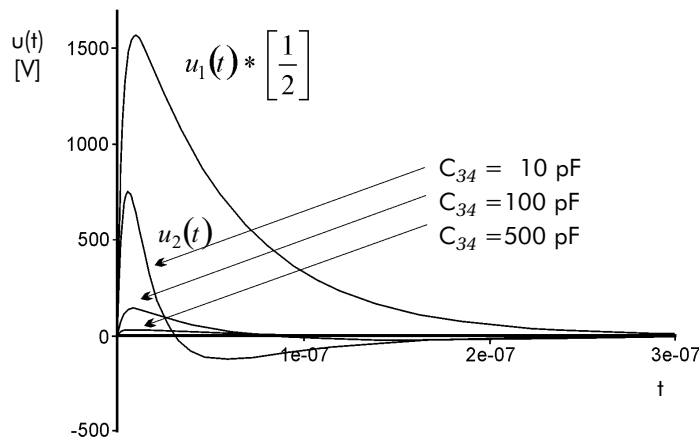

Figure 16 - Shielding of a burst pulse by shields of a different internal capacitive coupling

Radiation coupling

Electromagnetic fields travel through space with the velocity of light $c = 2.998 \times 10^8 \text{ m/s}$ and may influence electrical installations in the near or far surroundings of the source. Typical sources of electromagnetic fields are radio or TV transmitters, mobile telephones or any other kind of wireless applications. The high frequency parts of fast signals or of fast transients (ESD, surge, burst lightning) may also lead to the radiation of electromagnetic fields by cables or any other conductive parts of the electrical installation and may cause disturbances in electrical systems in other parts of the building.

If the disturbances on the power supply or data network contain high frequency components, other elements of the installation may act as antennas and radiate the electromagnetic fields. The Hertz Dipole may serve as an elementary model to estimate the magnitude of radiated fields. All conductive parts of the electrical installation may serve as antennas, including

- ◆ cables
- ◆ openings and slots of cases, cubicles etc.
- ◆ printed board strips.

Openings and slots of equipment cases radiate disturbances into the surrounding area or into the housing, so disturbing other objects in the environment and/or transmitting electromagnetic fields from the outside into the systems.

As an example we may look at an electrostatic discharge of a human body onto a metal plate. The arc of the electrostatic discharge not only transports a significant current, but also generates an electromagnetic field, which can easily reach a field strength of 0.5 - 4 kV at a distance of less than 1 m. These electromagnetic fields can disturb the electrical system inside an inadequate cubicle via the antenna properties of the slots.

Conducting elements such as cables and slots start to radiate when their linear dimension exceeds approximately half of the wavelength. The wavelength of an electromagnetic wave and its frequency f are related via the velocity of light by their relationship $\lambda = c / f$. Some typical pairs of values are shown in Table 2.

f [MHz]	λ [m]
0.1	3000
1	300
10	30
100	3
1000	0.3

Table 2 - Some values of frequencies and corresponding wavelengths

Fundamentals of Electromagnetic Compatibility (EMC)

In practice, housings cannot be completely closed. Openings such as entry ports for cables and ventilation slots and gaps around doors are unavoidable. These openings reduce the effective shielding of any housing. By intelligent construction of the housing, an acceptable level of shielding may be obtained.

The amount of leakage from a discontinuity in the shield depends mainly on three factors:

- ◆ the maximum linear dimension of the opening
- ◆ the wave impedance
- ◆ the frequency of the source.

For slots of a length of $l = \lambda / 2$ the shielding effectiveness is given by:

$$S = 20 \log \left(\frac{\lambda}{2l} \right) \quad (8)$$

Decreasing the slot length by a factor of 2 increases the shielding by 6 dB. Figure 17 shows the shielding effectiveness for various frequencies according to the slot length.

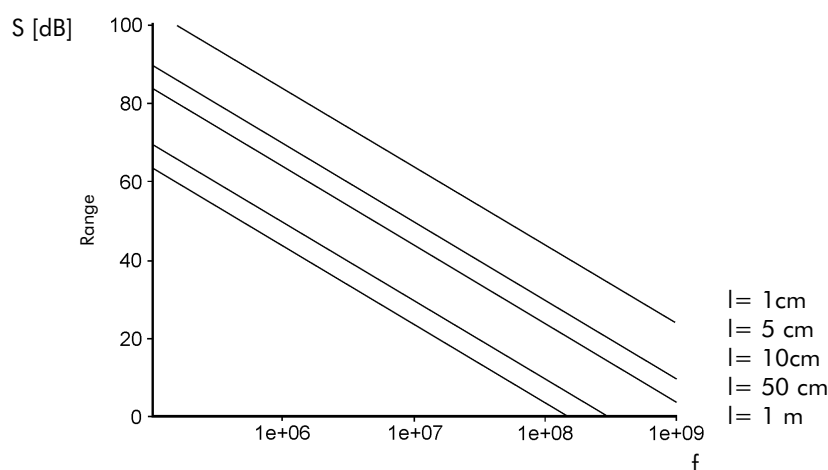

Figure 17 - Shielding effectiveness of a slot of various lengths as a function of frequency

In practical installations the maximal length of the slots should be smaller than 1/20 of the wavelength to guarantee a shielding effectiveness of at least 20 dB. From Equation 8 or from Figure 17 the corresponding maximal slot length for a required shielding effectiveness can be derived.

Complex EMI in practice

In a practical EMI situation all the elementary couplings discussed above coexist in a complex combination. A simple example of an automation system (Figure 18) shows that all the couplings apply to a single system in contact with its environment at the same time.

Any single system is embedded in a network of other systems and together they form a system of complex mutual EMI interrelations. To guarantee a proper functioning of the whole system, a so-called EMC matrix has to be generated and evaluated in the planning process for both new and refurbished buildings.

The EMC directive and its relevance to installations in buildings

EU directives are intended to ensure that all products made or sold in the EU conform to common standards and can be sold throughout the Member States without further regulation. In the case of EMC, EU directive EU 89/336, amended by directives 91/263/EEC, 92/31/EEC, 93/68/EEC and 93/97/EEC, gives

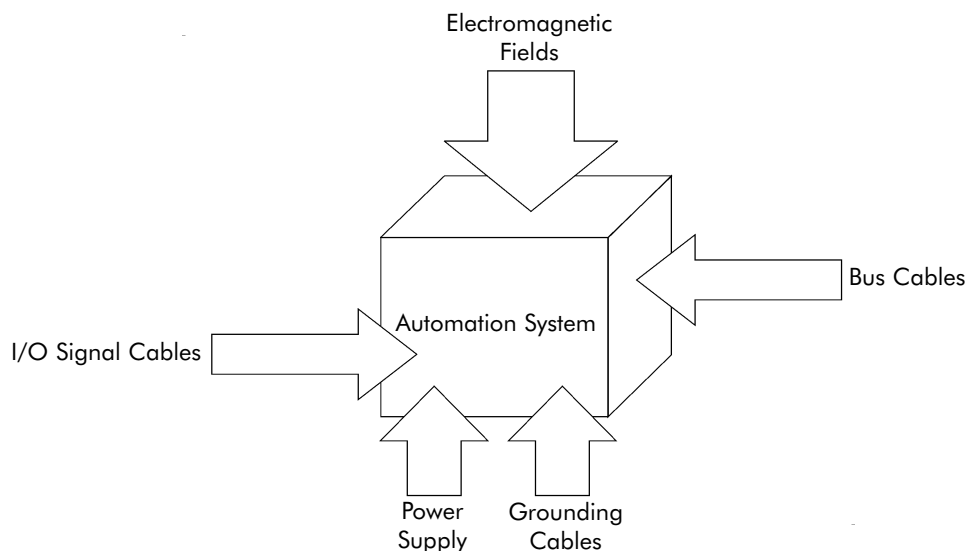

Figure 18 - Various couplings paths of an automation system

general standards for any product to guarantee electromagnetic compatibility by restricting the maximum level of emission of the product and its minimum immunity to external EMI. The manufacturer of any transportable product must declare the conformity of the product with the standards of the EU. The product has to be marked with the CE-sign to certify its compliance with the EMC and other directives to the consumer.

As far as electrical installations are concerned the declaration of conformity and CE-sign are not required, however compliance to the standards of the EU directive has to be guaranteed. This is the task of those responsible for the design, engineering and construction of the electrical installation. There are routes to guarantee and verify the compliance. The first is to use EMC qualified modules, which are installed by EMC trained personnel. The second is to use any available modules and certify the EMC compliance of the installation by measurement by an EMC laboratory or a notified body. In any case, the planner has to assert compliance with the EMC standards of the EU directive by appropriate documents. Additionally the 'manufacturer' of the installation must provide clear instructions for operation and maintenance in accordance with the Annex III of the EU directive. These instructions must give information on intended conditions of use, installation, assembly, adjustment, commissioning, use and maintenance. Where necessary, warnings about limitations of use must be included.

The safest way to guarantee the compliance of an electrical installation of a building may be to obey the following rules:

- ◆ Consider EMC from the very beginning, using the services of an EMC expert if necessary
- ◆ Use only modules and materials which are EMC certified
- ◆ Use EMC trained staff to carry out installation work
- ◆ EMC skilled engineers should supervise the installation work.

Since the subject of EMC has been introduced into training courses comparatively recently, there is a need of further education on this topic.

Bibliography

- G Durcansky: *EMC Correct Design of Apparatus (in German)*, Francis, 1995
- Electromagnetic Compatibility (EMC), Guide to the Application of Directive 89/336/EEC*, European Communities 1997
- S Fassbinder: *Disturbances of the Power Supply Network by Active and Passive Components (in German)*, VDE Verlag 2002
- J Goedbloed: *Electromagnetic Compatibility (in German)*, Pflaum Verlag, 1990
- M Grapentin: *EMC for the Installation of Buildings (in German)*, Verlag Technik, 2000
- E Habiger: *Electromagnetic Compatibility (in German)*, Hüthig, 1998
- B Keiser: *Principles of EMC*, Artech House, 1987
- VP Kodali: *Engineering Electromagnetic Compatibility*, IEEE Press, 1996
- A Kohling: *EMC of Buildings, Facilities and Apparatus (in German)*, VDE-Verlag, 1998
- G Lehner: *Theory of Electromagnetic Fields (in German)*, Springer, 1994
- H W Ott: *Noise Reduction Techniques in Electronic Systems*, A Wiley, 1988
- C R Paul: *Introduction to Electromagnetic Compatibility*, John Wiley, 1992
- D Peier: *Electromagnetic Compatibility (in German)*, Hüthig, 1990
- A Rodewald: *Electromagnetic Compatibility (in German)*, Vieweg, 1995
- W Rudolph, O Winter: *EMC according VDE 0100 (in German)*, VDE-Verlag, 2000
- W Rudolph: *An EMC Primer for Electricians (in German)*, VDE-Verlag, 2001
- Guideline Electromagnetic Compatibility (in German)*, EMC-Guideline ZX62920D, 1998, Groupe Schneider
- A Schwab: *Electromagnetic Compatibility (in German)*, Springer, 1996
- DIN/VDE 0848 : *Safety in Electrical, Magnetic and Electromagnetic Fields (in German)*

Notes

Reference & Founding* Partners

European Copper Institute* (ECI) <i>www.eurocopper.org</i>	ETSII - Universidad Politécnica de Madrid <i>www.etsii.upm.es</i>	LEM Instruments <i>www.lem.com</i>
Akademia Gorniczko-Hutnicza (AGH) <i>www.agh.edu.pl</i>	Fluke Europe <i>www.fluke.com</i>	MGE UPS Systems <i>www.mgeups.com</i>
Centre d'Innovació Tecnològica en Convertidors Estàtics i Accionaments (CITCEA-UPC) <i>www.citcea.upc.edu</i>	Hochschule für Technik und Wirtschaft* (HTW) <i>www.htw-saarland.de</i>	Otto-von-Guericke-Universität Magdeburg <i>www.uni-magdeburg.de</i>
Comitato Elettrotecnico Italiano (CEI) <i>www.ceiuni.it</i>	Hogeschool West-Vlaanderen Departement PIH <i>www.pih.be</i>	Polish Copper Promotion Centre* (PCPC) <i>www.miedz.org.pl</i>
Copper Benelux* <i>www.copperbenelux.org</i>	International Union for Electricity Applications (UIE) <i>www.uie.org</i>	Università di Bergamo* <i>www.unibg.it</i>
Copper Development Association* (CDA UK) <i>www.cda.org.uk</i>	ISR - Universidade de Coimbra <i>www.isr.uc.pt</i>	University of Bath <i>www.bath.ac.uk</i>
Deutsches Kupferinstitut* (DKI) <i>www.kupferinstitut.de</i>	Istituto Italiano del Rame* (IIR) <i>www.iir.it</i>	The University of Manchester <i>www.manchester.ac.uk</i>
Engineering Consulting & Design* (ECD) <i>www.ecd.it</i>	Katholieke Universiteit Leuven* (KU Leuven) <i>www.kuleuven.ac.be</i>	Wroclaw University of Technology* <i>www.pwr.wroc.pl</i>
EPRI Solutions Inc <i>www.epri.com/eprisolutions</i>	Laborelec <i>www.laborelec.com</i>	

Editorial Board

David Chapman (Chief Editor)	CDA UK	david.chapman@copperdev.co.uk
Prof Angelo Baggini	Università di Bergamo	angelo.baggini@unibg.it
Dr Araceli Hernández Bayo	ETSII - Universidad Politécnica de Madrid	ahernandez@etsii.upm.es
Prof Ronnie Belmans	UIE	ronnie.belmans@esat.kuleuven.ac.be
Dr Franco Bua	ECD	franco.bua@ecd.it
Jean-Francois Christin	MGE UPS Systems	jean-francois.christin@mgeups.com
Prof Anibal de Almeida	ISR - Universidade de Coimbra	adealmeida@isr.uc.pt
Hans De Keulenaer	ECI	hdk@eurocopper.org
Prof Jan Desmet	Hogeschool West-Vlaanderen	jan.desmet@howest.be
Dr ir Marcel Didden	Laborelec	marcel.didden@laborelec.com
Dr Johan Driesen	KU Leuven	johan.driesen@esat.kuleuven.ac.be
Stefan Fassbinder	DKI	sfassbinder@kupferinstitut.de
Prof Zbigniew Hanzelka	Akademia Gorniczko-Hutnicza	hanzel@uci.agh.edu.pl
Stephanie Horton	ERA Technology	stephanie.horton@era.co.uk
Dr Antoni Klajn	Wroclaw University of Technology	antoni.klajn@pwr.wroc.pl
Kees Kokee	Fluke Europe BV	kees.kokee@fluke.nl
Prof Dr rer nat Wolfgang Langguth	HTW	wlang@htw-saarland.de
Prof Henryk Markiewicz	Wroclaw University of Technology	henryk.markiewicz@pwr.wroc.pl
Carlo Masetti	CEI	masetti@ceiuni.it
Mark McGranaghan	EPRI Solutions	mmcgranaghan@eprisolutions.com
Dr Jovica Milanovic	The University of Manchester	jovica.milanovic@manchester.ac.uk
Dr Miles Redfern	University of Bath	eesmar@bath.ac.uk
Dr ir Tom Sels	KU Leuven	tom.sels@esat.kuleuven.ac.be
Prof Dr-Ing Zbigniew Styczynski	Universität Magdeburg	Sty@E-Technik.Uni-Magdeburg.de
Andreas Sumper	CITCEA-UPC	sumper@citcea.upc.edu
Roman Targosz	PCPC	cem@miedz.org.pl
Dr Ahmed Zobaa	Cairo University	azmailinglist@link.net



Prof. Dr. rer. nat. Wolfgang Langguth

Hochschule für
Technik und Wirtschaft
des Saarlandes
University of Applied Sciences



EMC-Laboratory
Hochschule für Technik und Wirtschaft
University of Applied Sciences
Goebenstrasse. 40
D66 117 Saarbrücken
Germany

Tel: 0049 681 5867279

Fax: 0049 681 5867302

Website: www.htw-saarland.de

Copper Development Association

Copper Development Association
1 Brunel Court
Corner Hall
Hemel Hempstead
HP3 9XX

Tel: 00 44 1442 275700

Fax: 00 44 1442 275716

Email: helpline@copperdev.co.uk

Websites: www.cda.org.uk and www.brass.org



European Copper Institute
168 Avenue de Tervueren
B-1150 Brussels
Belgium

Tel: 00 32 2 777 70 70

Fax: 00 32 2 777 70 79

Email: eci@eurocopper.org

Website: www.eurocopper.org