

Power Quality Application Guide

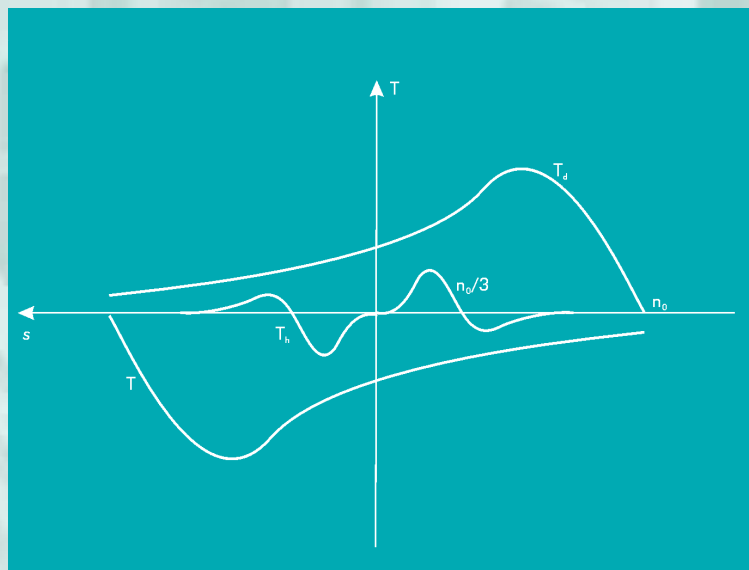

Voltage Disturbances *Introduction to Unbalance*

5.1.3

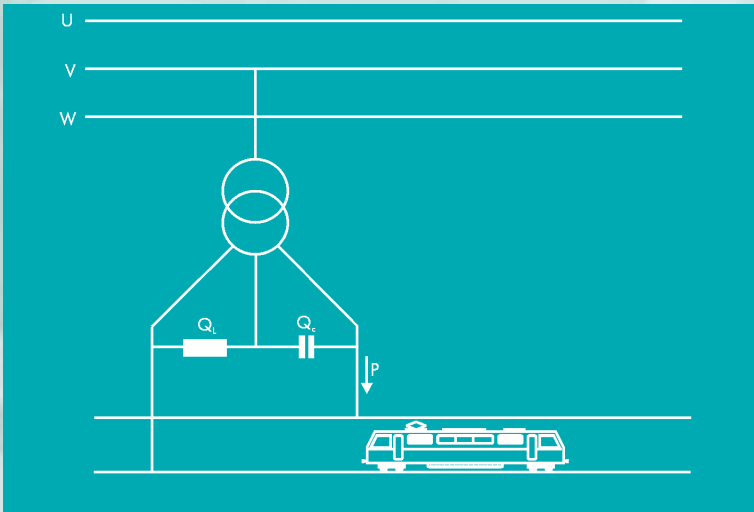

Voltage Disturbances

Voltage Disturbances

Introduction to Unbalance

Dr Johan Driesen & Dr Thierry Van Craenenbroeck
Katholieke Universiteit Leuven
May 2002

European Copper Institute (ECI)

The European Copper Institute is a joint venture between ICA (International Copper Association) and IWCC (International Wrought Copper Council) contributing members. Through its membership, ECI acts on behalf of the world's largest copper producers and Europe's leading fabricators in promoting copper in Europe. Formed in January 1996, ECI is supported by a network of ten Copper Development Associations ('CDAs') in Benelux, France, Germany, Greece, Hungary, Italy, Poland, Scandinavia, Spain and the UK. It furthers the efforts initially undertaken by the Copper Products Development Association, formed in 1959, and INCRA (International Copper Research Association) formed in 1961.

Copper Development Association (CDA)

Copper Development Association is a non-trading organisation sponsored by the copper producers and fabricators to encourage the use of copper and copper alloys and to promote their correct and efficient application. Its services, which include the provision of technical advice and information, are available to those interested in the utilisation of copper in all its aspects. The Association also provides a link between research and the user industries and maintains close contact with the other copper development organisations throughout the world.

CDA is an IEE endorsed provider of seminar training and learning resources.

Acknowledgement

This project has been carried out with the support of the European Community and International Copper Association, Ltd.

Disclaimer

European Copper Institute, Katholieke Universiteit Leuven and Copper Development Association disclaim liability for any direct, indirect, consequential or incidental damages that may result from the use of the information, or from the inability to use the information or data contained within this publication.

Copyright© European Copper Institute, Katholieke Universiteit Leuven and Copper Development Association.

Reproduction is authorised providing the material is unabridged and the source is acknowledged.

Copper Development Association

Copper Development Association
5 Grovelands Business Centre
Boundary Way
Hemel Hempstead HP2 7TE
United Kingdom

Tel: 00 44 1442 275700
Fax: 00 44 1442 275716
Email: helpline@copperdev.co.uk
Websites: www.cda.org.uk and www.brass.org



European Copper Institute
168 Avenue de Tervueren
B-1150 Brussels
Belgium

Tel: 00 32 2 777 70 70
Fax: 00 32 2 777 70 79
Email: eci@eurocopper.org
Website: www.eurocopper.org

Voltage Disturbances

Introduction to Unbalance

Introduction

This text deals with the unbalance of voltages and currents. As unbalanced currents are an important cause of non-symmetrical voltages and since voltage unbalance is a recognized power quality parameter, this text, as its title indicates, mainly refers to the unbalance of sinusoidal voltages.

First of all, the phenomenon is defined. Then, some basic parameters required for its quantification are given. The less mathematically interested reader can omit the equations and move on to the more descriptive material dealing with limits, causes and effects. Finally, some mitigation techniques are summarized.

What is unbalance?

Definition

A three-phase power system is called balanced or symmetrical if the three-phase voltages and currents have the same amplitude and are phase shifted by 120° with respect to each other. If either or both of these conditions are not met, the system is called unbalanced or asymmetrical.

In this text, it is implicitly assumed that the waveforms are sinusoidal and thus do not contain harmonics.

Quantification

To quantify an unbalance in voltage or current of a three-phase system, the so-called Fortescue components or symmetrical components are used. The three-phase system is decomposed into a so-called *direct* or *positive-sequence*, *inverse* or *negative-sequence* and *homopolar* or *zero-sequence* system, indicated by subscripts d, i, h (in some texts the subscripts $1, 2, 0$ are used).

They are calculated using matrix transformations of the three-phase voltage or current phasors. The subscripts u, v, w indicate the different phases. (Sometimes the subscripts a, b and c are used.) The expressions here are formulated for the voltage U , but this variable can be replaced by the current I without any problem:

$$\begin{bmatrix} U_h \\ U_d \\ U_i \end{bmatrix} = \frac{1}{3} \cdot \begin{bmatrix} 1 & 1 & 1 \\ 1 & a & a^2 \\ 1 & a^2 & a \end{bmatrix} \cdot \begin{bmatrix} U_u \\ U_v \\ U_w \end{bmatrix} \quad (1)$$

where the rotation operator a is given by:

$$a = e^{j120^\circ}$$

These transformations are energy-invariant, so any power quantity calculated with the original or transformed values will result in the same value.

The inverse transformation is:

$$\begin{bmatrix} U_u \\ U_v \\ U_w \end{bmatrix} = \begin{bmatrix} 1 & 1 & 1 \\ 1 & a^2 & a \\ 1 & a & a^2 \end{bmatrix} \cdot \begin{bmatrix} U_h \\ U_d \\ U_i \end{bmatrix} \quad (2)$$

Introduction to Unbalance

The direct system is associated with a positively rotating field whereas the inverse system yields a negative rotating field (Figure 1). In the case of AC electrical machines, this is a physically correct interpretation for the rotating magnetic field.

Homopolar components have identical phase angles and only oscillate. In systems without neutral conductors homopolar currents obviously cannot flow, but significant voltage differences between the 'zero voltages' at the neutral points of the Y-connections in the supply system and the loads may arise.

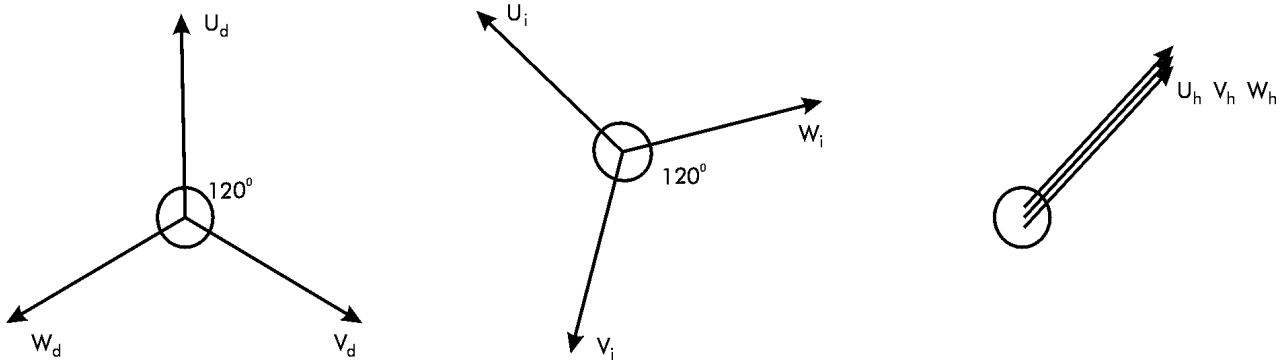

Figure 1 - Graphical representation of the symmetrical components; note the inverse labelling of the positive sequence (leftmost) and negative sequence (middle) contributions to the actual voltage phasors

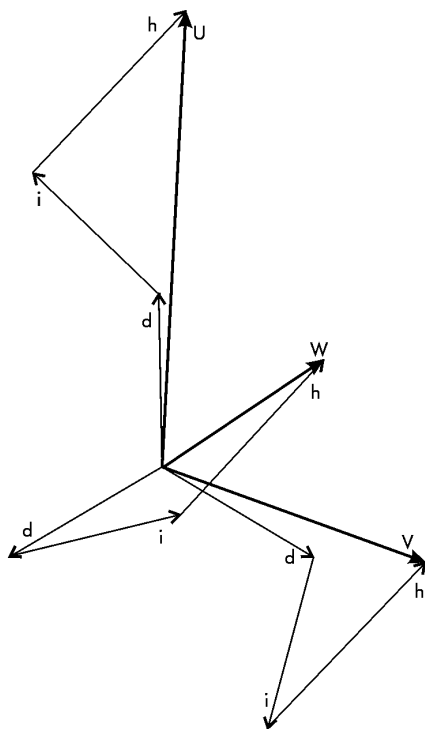

Figure 2 - Graphical decomposition using the components in Figure 1 (the respective contributions to the three phases as indicated with U, V, W are added as phasors to obtain the actual unbalanced system)

Figure 2 illustrates the decomposition of an unbalanced system into its components.

Measuring these components is not straightforward in practice - especially for the positive and negative sequence components. A digital measurement device performing the above-mentioned mathematical operation on the sampled voltages and currents leads to a simpler implementation than is possible with classical analogue equipment.

The ratios u_U (voltage) and u_I (current) between the magnitudes of negative and positive sequence components of voltage and current respectively are a measure of the unbalance (in %):

$$u_U = \frac{U_i}{U_d} \cdot 100\% \quad (3)$$

Such ratios are for instance used in standards dealing with power quality issues, such as EN-50160 or the IEC 1000-3-x series.

A similar ratio is sometimes defined for the homopolar vs. direct magnitude ratio as well, when appropriate.

An easier, approximate, way to calculate the voltage ratio is:

$$u_U \approx \frac{S_L}{S_{SC}} \cdot 100\% \quad (4)$$

Introduction to Unbalance

This ratio only uses the apparent power of the load S_L and the short-circuit power S_{SC} of the supply circuit. Complete measurement procedures to determine these parameters are described in the standards. They employ statistical techniques to determine an average of (3)-(4), over a certain time span.

Limits

International standards (e.g. EN-50160 or the IEC 1000-3-x series) give limits for the unbalance ratio defined by (3) of $< 2\%$ for LV and MV systems and $< 1\%$ for HV, measured as 10-minute values, with an instantaneous maximum of 4% . However, this limit can be locally reduced, even as low as 0.25% at the British side of the Channel Tunnel, where the train system represents a large single-phase load. The reason for the tighter limits on high-voltage systems is that they are designed to be used to their maximum capacity with a balanced three-phase load. Any unbalance causes inefficient operation of the often highly loaded transmission systems. In the design of distribution systems (lower voltages), the supply of single-phase loads is one of the key purposes, so the system and the connected loads must be designed and implemented to be more tolerant of unbalance.

As an example, the required short-circuit power for a double high-speed railway track with a rated power of two times 15 MVA is estimated (typical French TGV arrangement). Using the ratio (4), the short-circuit power should be at least 3 GVA to maintain the 1% voltage unbalance level, explaining why a connection to the extra high voltage system is a necessity.

More detailed standardisation can be found in IEC 61000-2-x, as a part of EMC standardisation, and EN 50160, describing the voltage characteristics at the point-of-common coupling (PCC). Next to this, the different European countries and the electricity companies operating therein often employ their own additional rules for the 'emission' of unbalanced load currents.

How is unbalance caused?

The system operator tries to provide a balanced system voltage at the PCC between the distribution grid and the customer's internal network. Under normal conditions, these voltages are determined by the:

- ◆ terminal voltages of the generators
- ◆ impedance of electricity system
- ◆ currents drawn by the loads throughout the transmission and distribution grid.

The system voltages at a generation site are generally highly symmetrical due to the construction and operation of synchronous generators used in large centralised power plants. Therefore, the central generation does not in general contribute to unbalance. Even with induction (asynchronous) generators, as used for instance in some types of wind turbines, a balanced three-phase set of voltages is obtained.

However, where small-scale distributed or embedded generation, installed at the customer's site, has become more popular and taken up a significant share of the electricity production, the situation is different. Many of these relatively small units, such as photovoltaic installations, are connected to the grid at LV by means of single-phase power electronic inverter units. The connection point has a relatively high impedance (the short-circuit power is relatively low), leading to a potentially larger unbalance of the voltage (equation (4)) than is the case for connections at higher voltage level.

The impedance of electricity system components is not exactly the same for each phase. The geometrical configuration of overhead lines, asymmetric with respect to the ground for instance, causes a difference in the electrical parameters of the line. Generally, these differences are very small and their effect can be neglected when sufficient precautions, such as the transposition of lines, are taken.

In most practical cases, the asymmetry of the loads is the main cause of unbalance.

At high and medium voltage level, the loads are usually three-phase and balanced, although large single- or dual-phase loads can be connected, such as AC rail traction (e.g. high-speed railways, Figure 3) or induction furnaces (large metal melting systems employing highly irregular powerful arcs to generate heat).

Introduction to Unbalance

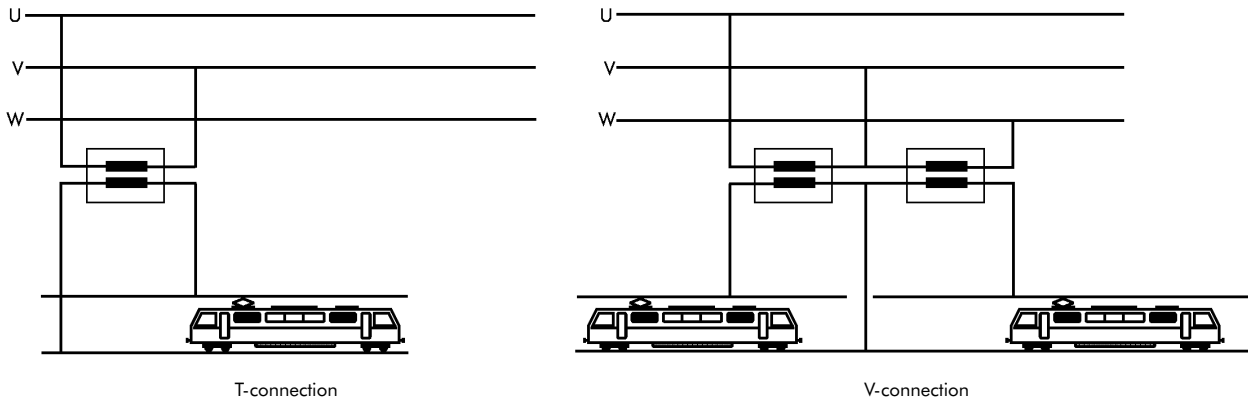

Figure 3 - AC railway connections as examples of asymmetrical load connections

Low voltage loads are usually single-phase, e.g. PCs or lighting systems, and the balance between phases is therefore difficult to guarantee. In the layout of an electrical wiring system feeding these loads, the load circuits are distributed amongst the three-phase systems, for instance one phase per floor of an apartment or office building or alternating connections in rows of houses. Still, the balance of the equivalent load at the central transformer fluctuates because of the statistical spread of the duty cycles of the different individual loads.

Abnormal system conditions also cause phase unbalance. Phase-to-ground, phase-to-phase and open-conductor faults are typical examples. These faults cause voltage dips in one or more of the phases involved and may even indirectly cause overvoltages on the other phases. The system behaviour is then unbalanced by definition, but such phenomena are usually classified under voltage disturbances, which are discussed in the corresponding application guides, since the electricity grid's protection system should cut off the fault.

What are the consequences?

The sensitivity of electrical equipment to unbalance differs from one appliance to another. A short overview of the most common problems is given below:

Induction machines

These are AC asynchronous machines with internally induced rotating magnetic fields. The magnitude is proportional to the amplitude of the direct and/or inverse components. The rotational sense of the field of the inverse component is opposite to the field of the direct component. Hence, in the case of an unbalanced supply, the total rotating magnetic field becomes 'elliptical' instead of circular. Induction machines face three kinds of problems due to unbalance. First, the machine cannot produce its full torque as the inversely rotating magnetic field of the negative-sequence system causes a negative braking torque that has to be subtracted from the base torque linked to the normal rotating magnetic field. Figure 4 shows the different torque-speed characteristics of an induction machine under unbalanced supply. The actual steady-state curve is the weighted sum of these curves with the squared unbalance ratios as weights as the torque scales with the square of the load. It can be seen that in the normal operating region, being the almost straight line section of T_d (the part starting at the top of the curve, eventually crossing the horizontal axis at synchronous speed), T_i and T_h are both negative. These characteristics can be measured with the motor connected as shown in Figure 5.

Secondly, the bearings may suffer mechanical damage because of induced torque components at double system frequency.

Finally, the stator and, especially, the rotor are heated excessively, possibly leading to faster thermal ageing. This heat is caused by induction of significant currents by the fast rotating (in the relative sense) inverse magnetic field, as seen by the rotor. To be able to deal with this extra heating, the motor must be derated, which may require a machine of a larger power rating to be installed.

Introduction to Unbalance

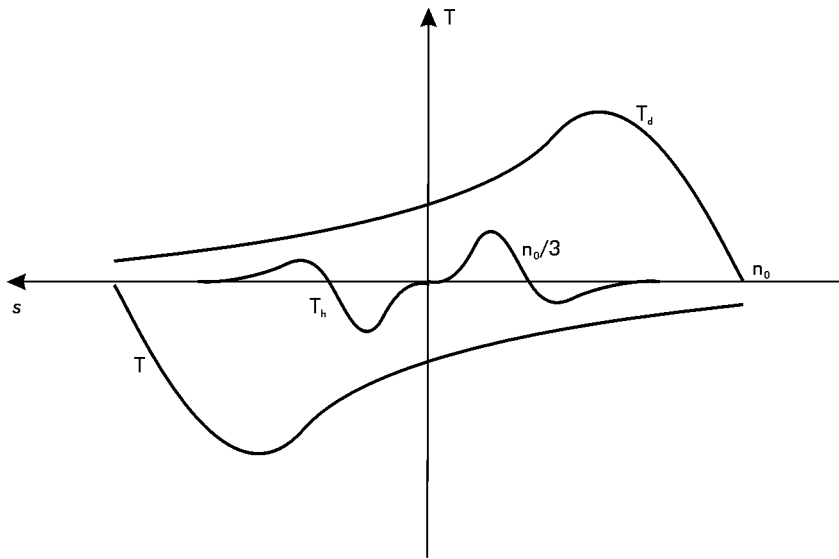

Figure 4 - Torque-speed (slip) characteristics of an induction machine under unbalanced supply conditions

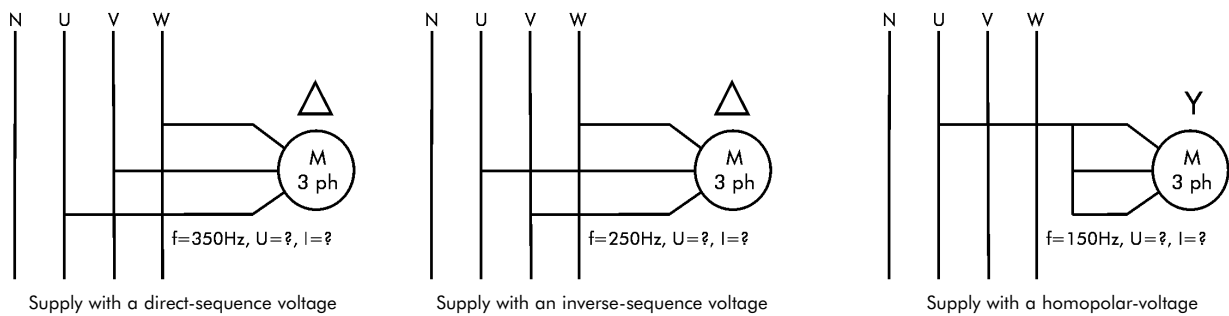

Figure 5 - Supply schemes to feed an induction motor with a certain unbalance component

Synchronous generators

Synchronous generators are AC machines as well, for instance used in local generation such as CHP units. They exhibit phenomena similar to those described for induction machines, but mainly suffer from excess heating. Special care must be devoted to the design of stabilising damper windings on the rotor, where the currents are induced by the indirect and homopolar components.

Capacity of transformers, cables and lines

The capacity of transformers, cables and lines is reduced due to negative sequence components. The operational limit is in fact determined by the RMS rating of the total current, being partially made up of 'useless' non-direct sequence currents as well. This has to be considered when setting trigger points of protection devices, operating on the total current. The maximum capacity can be expressed by a derating factor, to be supplied by the manufacturer, which can be used to select a larger system, capable of handling the load.

Transformers

Transformers subject to negative sequence voltages transform them in the same way as positive-sequence voltages. The behaviour with respect to homopolar voltages depends on the primary and secondary connections and, more particularly, the presence of a neutral conductor. If, for instance, one side has a

Introduction to Unbalance

three-phase four-wire connection, neutral currents can flow. If at the other side the winding is delta-connected, the homopolar current is transformed into a circulating (and heat-causing) current in the delta. The associated homopolar magnetic flux passes through constructional parts of the transformer causing parasitic losses in parts such as the tank, sometimes requiring an additional derating.

Electronic power converters

These are present in many devices such as adjustable speed drives, PC power supplies, efficient lighting and so on. They can be faced with additional, uncharacteristic, harmonics although, in general, the total harmonic distortion remains more or less constant. The design of passive filter banks dealing with these harmonics must take this phenomenon into account. This subject is covered in another Section of this Guide.

The devices discussed above are obviously three-phase loads. Of course, single-phase loads may also be affected by voltage variations on the supply resulting from unbalance effects.

How can unbalance be mitigated?

To decrease the effects of unbalance, several actions can be taken, with different degrees of technical complexity.

The first and most basic solution is to rearrange or redistribute the loads in such a way that the system becomes more balanced. For certain applications, there is a possibility of reducing unbalance by changing the operating parameters.

In order to reduce the influence of negative sequence currents, causing negative sequence voltage drops, on the supply voltage, a low internal system impedance is required. This may be achieved by connecting the unbalanced loads at points with higher short circuit level, or by other system measures to reduce the internal impedance.

Another type of mitigation technique is the use of special transformers, such as Scott- and Steinmetz-transformers:

- ◆ The 'Scott-transformer' consists of two single-phase transformers, with special winding ratios, hooked up to a three-phase system. They are connected in such a way that at the output, a two-phase orthogonal voltage system is generated allowing the connection of two single-phase systems. This set-up presents a balanced three-phase power to the grid.
- ◆ A 'Steinmetz-transformer' is in fact a three-phase transformer with an extra power balancing load, consisting of a capacitor and an inductor rated proportional to the single-phase load (Figure 6). When the reactive power rating of the inductor and the capacitor equals the active power rating of the load, divided by $\sqrt{3}$, the three-phase grid sees a balanced load. The three-phase rated power of the transformer equals the single-phase load's active power. Note that balancing is only perfect for loads with an active power equal to the value used to design the system.

Finally, special fast-acting power electronic circuits, such as 'Static Var Compensators' can be configured to limit the unbalance. These behave as if they were rapidly changing complementary impedances, compensating for changes in impedance of the loads on each phase. Also, they are capable of compensating unwanted reactive power. However, these are expensive devices, and are only used for large loads (e.g. arc furnaces) when other solutions are insufficient.

Other types of power conditioners that can deal with unbalanced systems as well as other power quality problems are in development but are not yet ready for general application.

Introduction to Unbalance

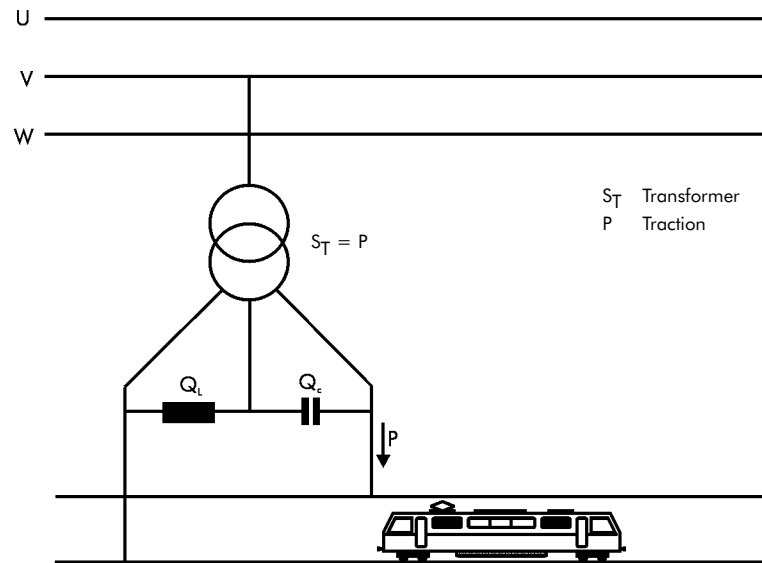

Figure 6 - Single-phase load connected to a three-phase grid using a Steinmetz transformer configuration

Conclusion

Unbalance is a serious power quality problem, mainly affecting low-voltage distribution systems, as for instance encountered in office buildings with abundant PCs and lighting. However, it can be quantified in a relatively simple manner resulting in parameters that can be compared to standardized values.

This text explains the main causes of unbalance and elaborates on the most important consequences. Special attention is paid to rotating machines, mainly induction machines, and transformers.

The main mitigation techniques for this specific problem are briefly summarised.

Network Partners

Copper Benelux

168 Avenue de Tervueren
B-1150 Brussels
Belgium

Tel: 00 32 2 777 7090
Fax: 00 32 2 777 7099
Email: mail@copperbenelux.org
Web: www.copperbenelux.org

Contact: Mr B Dôme

Copper Development Association

5 Grovelands Business Centre
Boundary Way
Hemel Hempstead HP2 7TE
United Kingdom

Tel: 00 44 1442 275700
Fax: 00 44 1442 275716
Email: helpline@copperdev.co.uk
Webs: www.cda.org.uk & www.brass.org

Contact: Mrs A Vessey

Deutsches Kupferinstitut e.V

Am Bonnheshof 5
D-40474 Duesseldorf
Germany

Tel: 00 49 211 4796 323
Fax: 00 49 211 4796 310
Email: sfassbinder@kupferinstitut.de
Web: www.kupferinstitut.de

Contact: Mr S Fassbinder

ECD Services

Via Cardinal Maffi 21
I-27100 Pavia
Italy

Tel: 00 39 0382 538934
Fax: 00 39 0382 308028
Email: info@ecd.it
Web: www.ecd.it

Contact: Dr A Baggini

European Copper Institute

168 Avenue de Tervueren
B-1150 Brussels
Belgium

Tel: 00 32 2 777 70 70
Fax: 00 32 2 777 70 79
Email: eci@eurocopper.org
Web: www.eurocopper.org

Contact: Mr H De Keulenaer

Hevrox

Schoebroekstraat 62
B-3583 Beringen
Belgium

Tel: 00 32 11 454 420
Fax: 00 32 11 454 423
Email: info@hevrox.be

Contact: Mr I Hendriks

HTW

Goebenstrasse 40
D-66117 Saarbruecken
Germany

Tel: 00 49 681 5867 279
Fax: 00 49 681 5867 302
Email: wlang@htw-saarland.de

Contact: Prof Dr W Langguth

Istituto Italiano del Rame

Via Corradino d'Ascanio 4
I-20142 Milano
Italy

Tel: 00 39 02 89301330
Fax: 00 39 02 89301513
Email: info@iir.it
Web: www.iir.it

Contact: Mr V Loconsolo

KU Leuven

Kasteelpark Arenberg 10
B-3001 Leuven-Heverlee
Belgium

Tel: 00 32 16 32 10 20
Fax: 00 32 16 32 19 85
Email: ronnie.belmans@esat.kuleuven.ac.be

Contact: Prof Dr R Belmans

Polish Copper Promotion Centre SA

Pl.1 Maja 1-2
PL-50-136 Wroclaw
Poland

Tel: 00 48 71 78 12 502
Fax: 00 48 71 78 12 504
Email: pcpm@miedz.org.pl

Contact: Mr P Jurasz

TU Bergamo

Viale G Marconi 5
I-24044 Dalmine (BG)
Italy

Tel: 00 39 035 27 73 07
Fax: 00 39 035 56 27 79
Email: graziana@unibg.it

Contact: Prof R Colombi

TU Wroclaw

Wybrzeze Wyspianskiego 27
PL-50-370 Wroclaw
Poland

Tel: 00 48 71 32 80 192
Fax: 00 48 71 32 03 596
Email: i8@elektryk.ie.pwr.wroc.pl

Contact: Prof Dr H Markiewicz

Dr Johan Driesen

Katholieke Universiteit Leuven
Electrical Engineering
Kasteelpark Arenberg 10
3001 Leuven
Belgium

Tel: 00 32 16 321020
Fax: 00 32 16 321985
E-mail: johan.driesen@esat.kuleuven.ac.be
Web: www.esat.kuleuven.ac.be

Dr Thierry Van Craenenbroeck

Katholieke Universiteit Leuven
Electrical Engineering
Kasteelpark Arenberg 10
3001 Leuven
Belgium

Tel: 00 32 16 321020
Fax: 00 32 16 321985
Web: www.esat.kuleuven.ac.be

 **Copper Development Association**

Copper Development Association
5 Grovelands Business Centre
Boundary Way
Hemel Hempstead HP2 7TE
United Kingdom

Tel: 00 44 1442 275700
Fax: 00 44 1442 275716
Email: helpline@copperdev.co.uk
Websites: www.cda.org.uk and www.brass.org



European Copper Institute
168 Avenue de Tervueren
B-1150 Brussels
Belgium

Tel: 00 32 2 777 70 70
Fax: 00 32 2 777 70 79
Email: eci@eurocopper.org
Website: www.eurocopper.org