

Sheet - so you want to form it.

# Metal Spinners Group

Sheet - so you want to form it.



# Sheet - so you want to form it.

## Law of the Levers

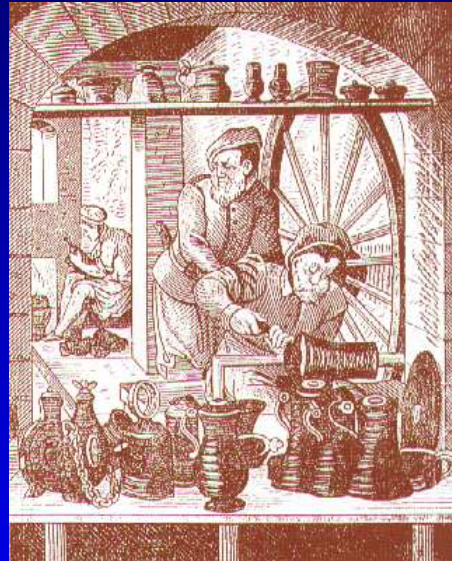
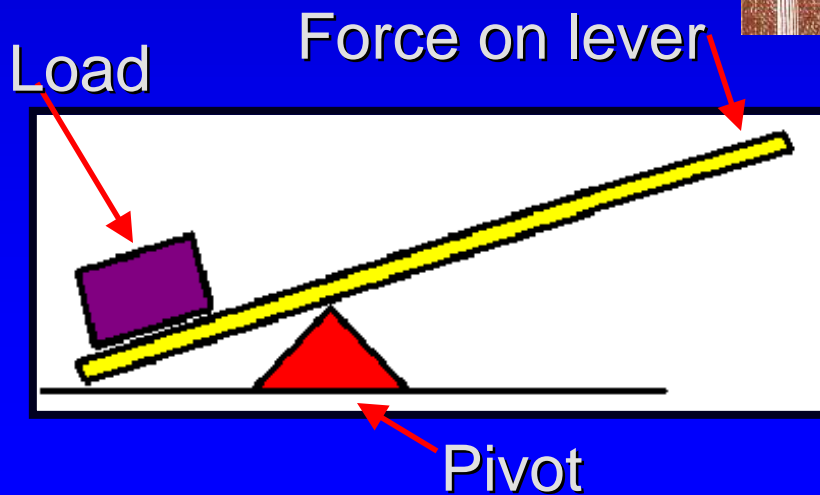
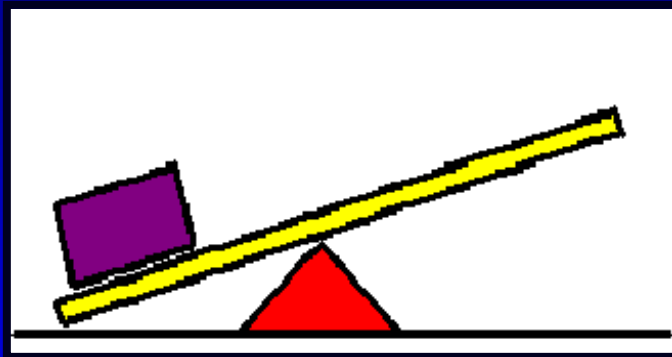

## Hand Lathes



# Sheet - so you want to form it.

Forming  
Tool

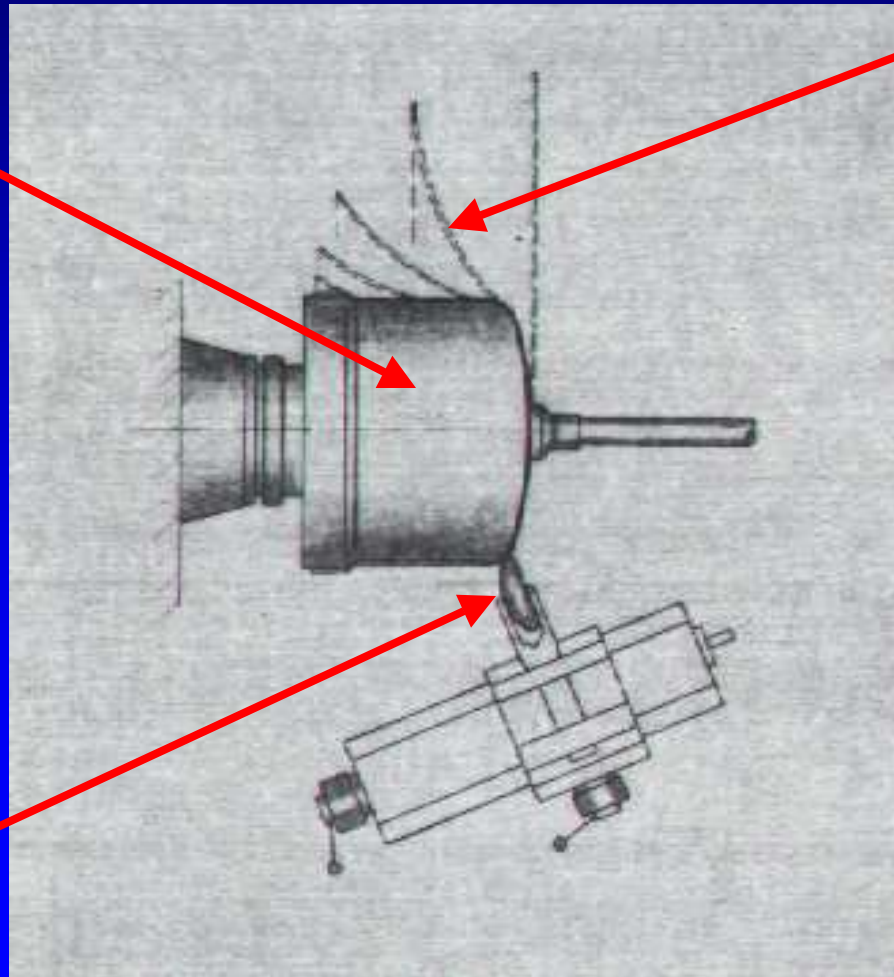

Forward  
& Back  
Passes  
Used To  
Spin  
Material  
Over  
Forming  
Tool

Spinning  
Roller

# Sheet - so you want to form it.

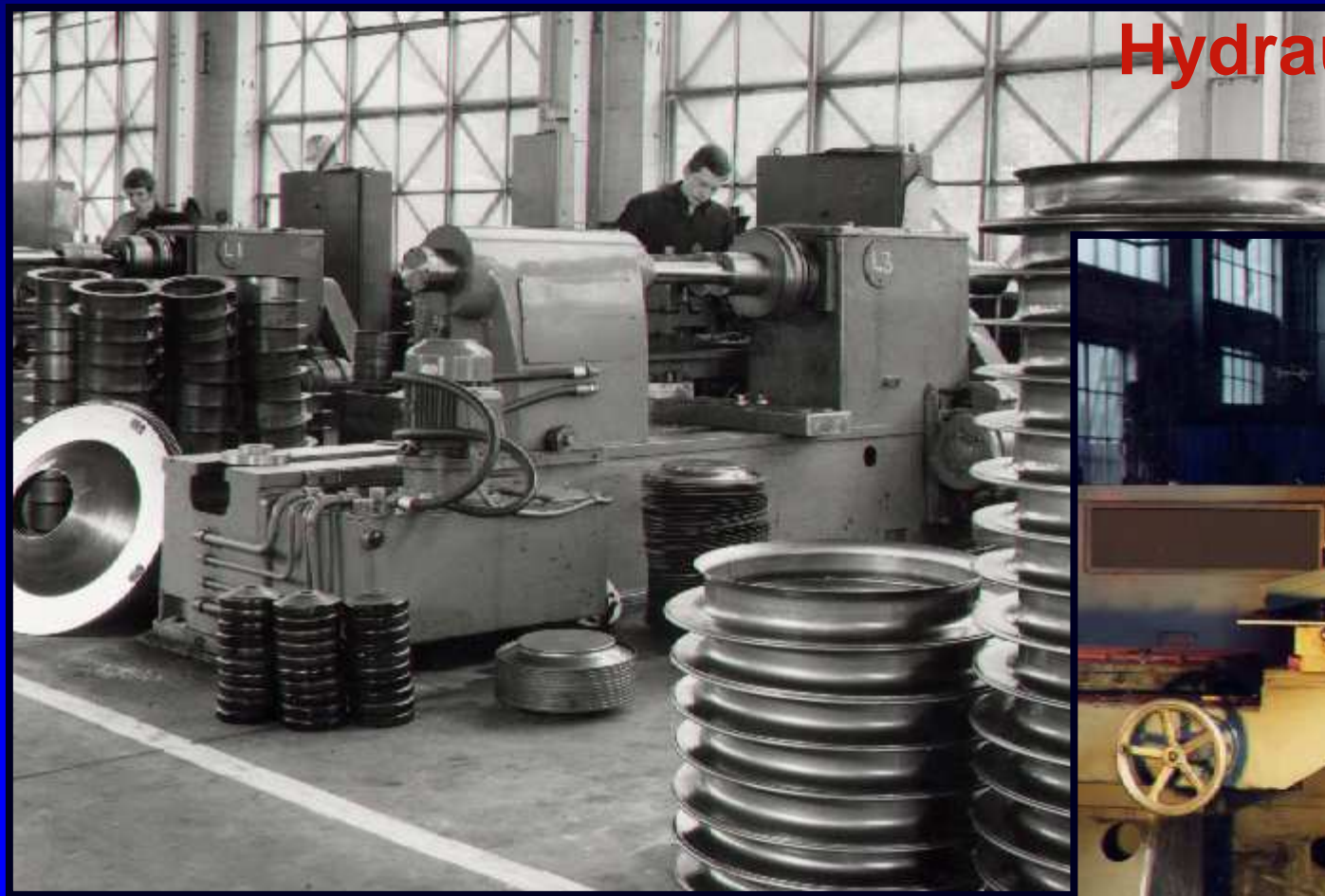

**Hydraulic Spinning  
Lathes**



Sheet - so you want to form it.



Sheet - so you want to form it.





# Sheet - so you want to form it.

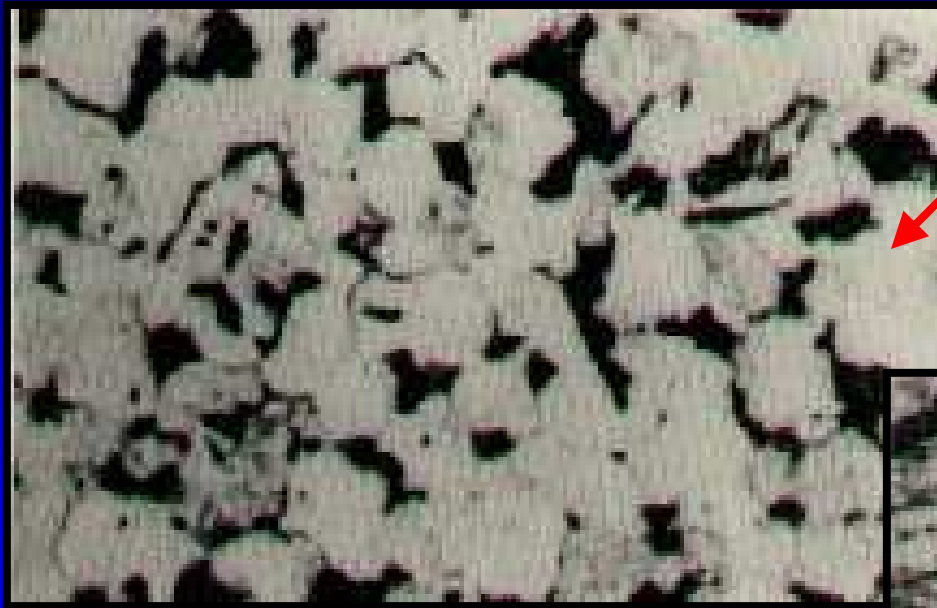

Sheet Steel Before Deformation.

Stretched Steel Structure After Cold Flow Forming

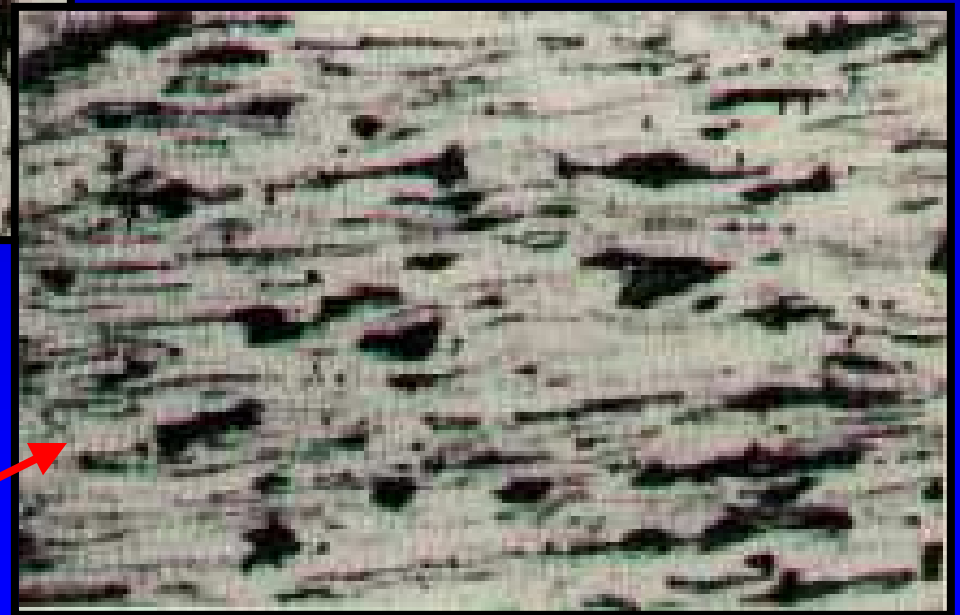



Sheet - so you want to form it.

**Hardness > Increased**

**Tensile Strength > Increased**

**Elongation > Decreased**

# Sheet - so you want to form it.

PNC

MALE FORMER

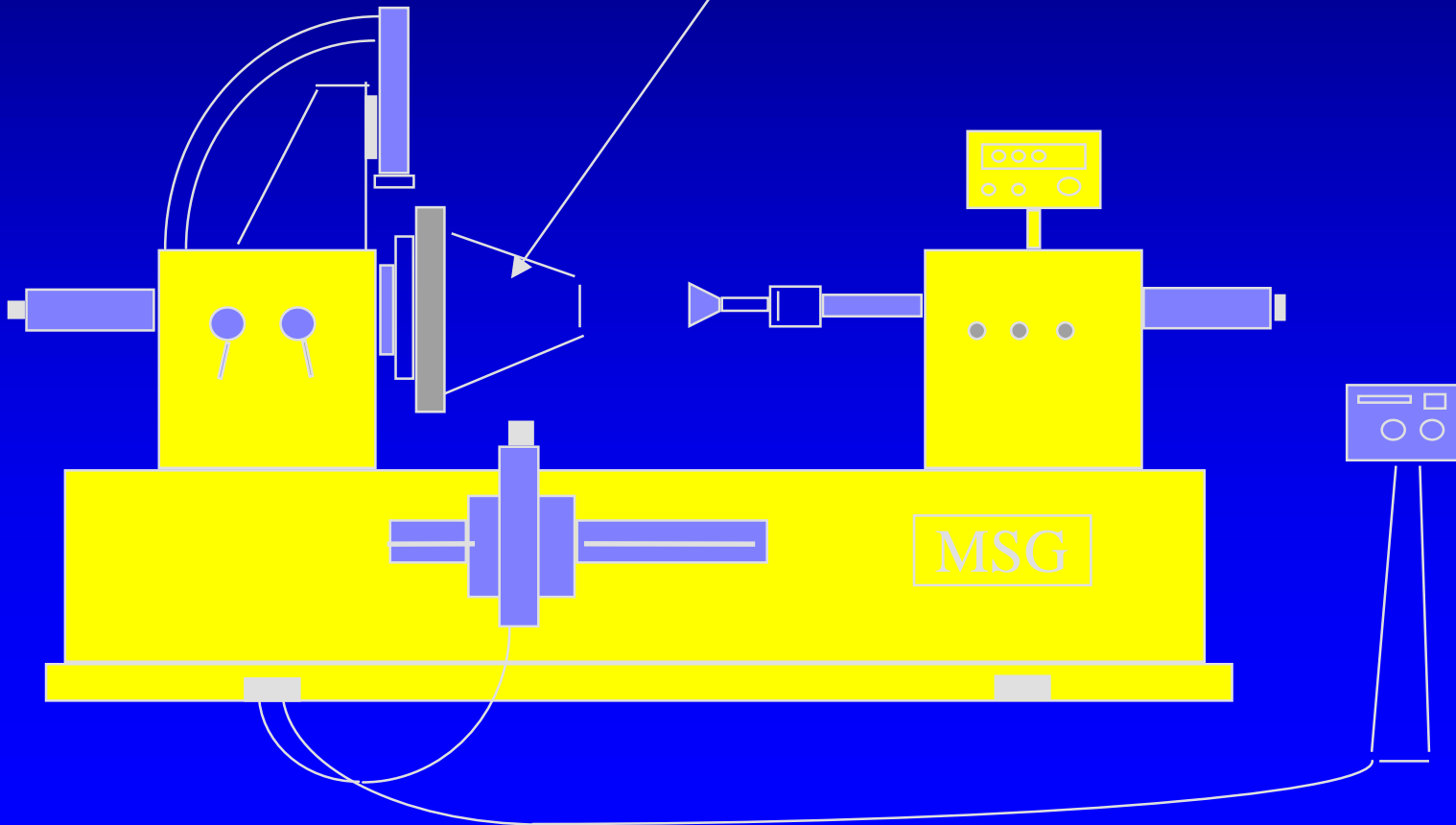

# Sheet - so you want to form it.

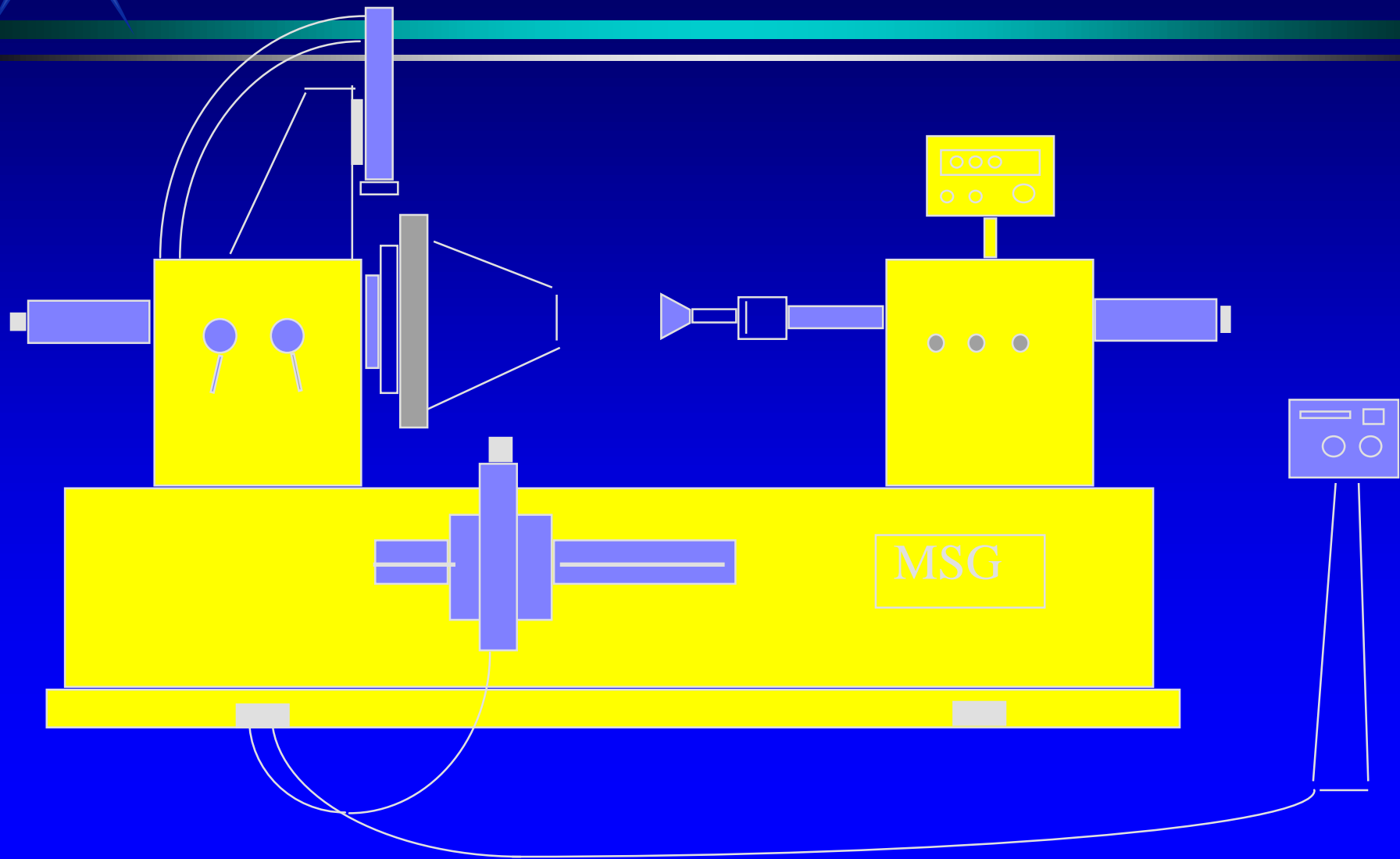

Sheet - so you want to form it.

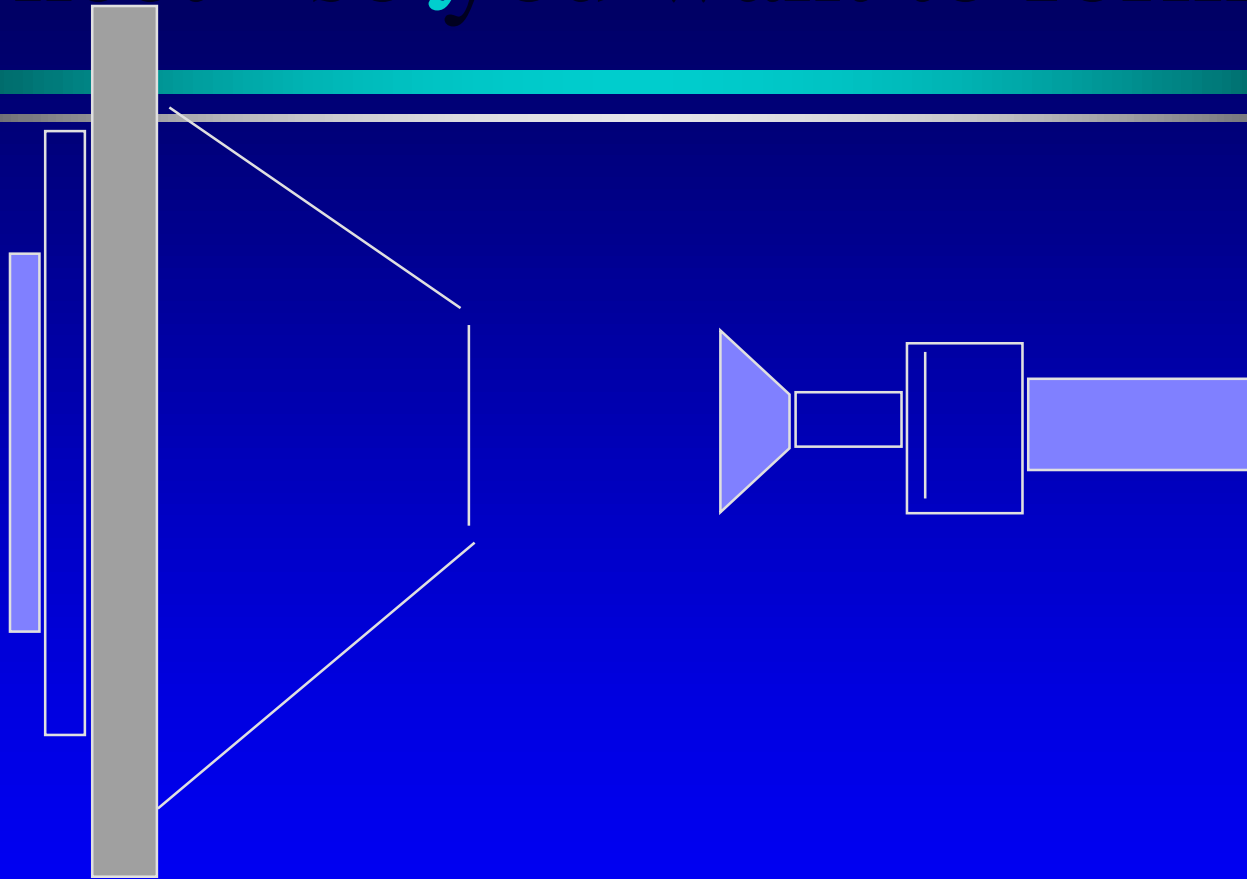

Sheet - so you want to form it.

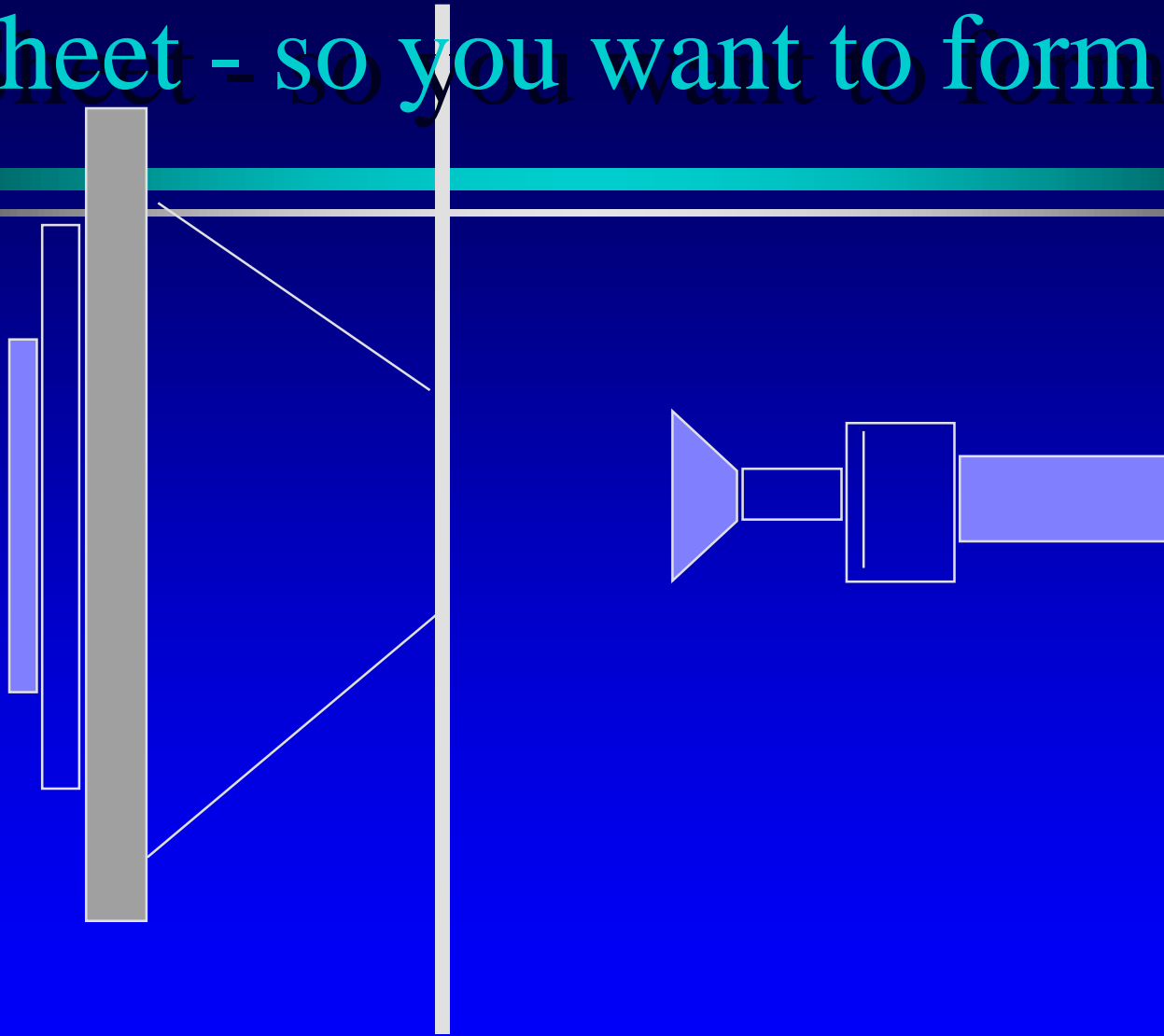

Sheet - so you want to form it.

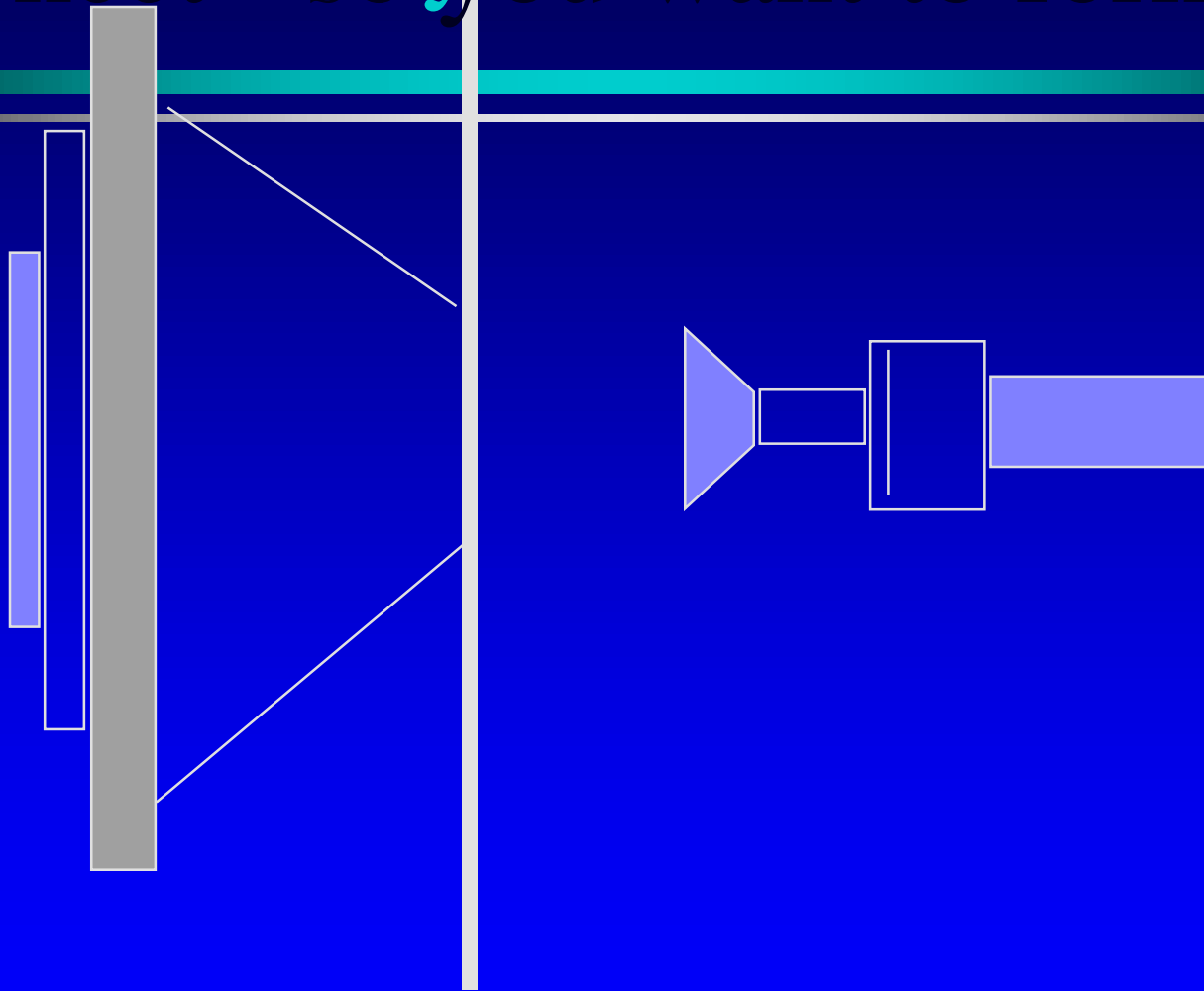

Sheet - so you want to form it.

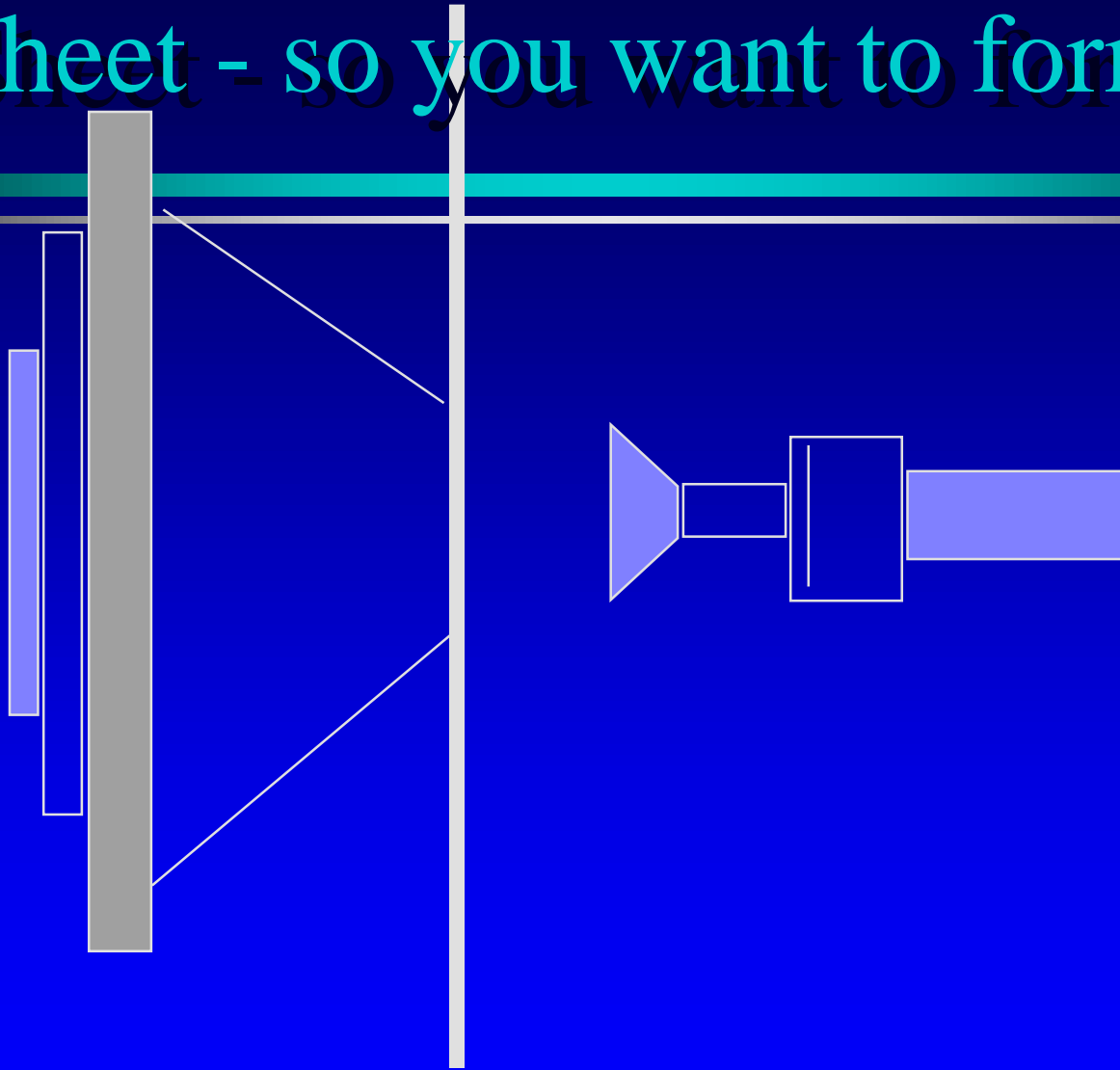

Sheet - so you want to form it.

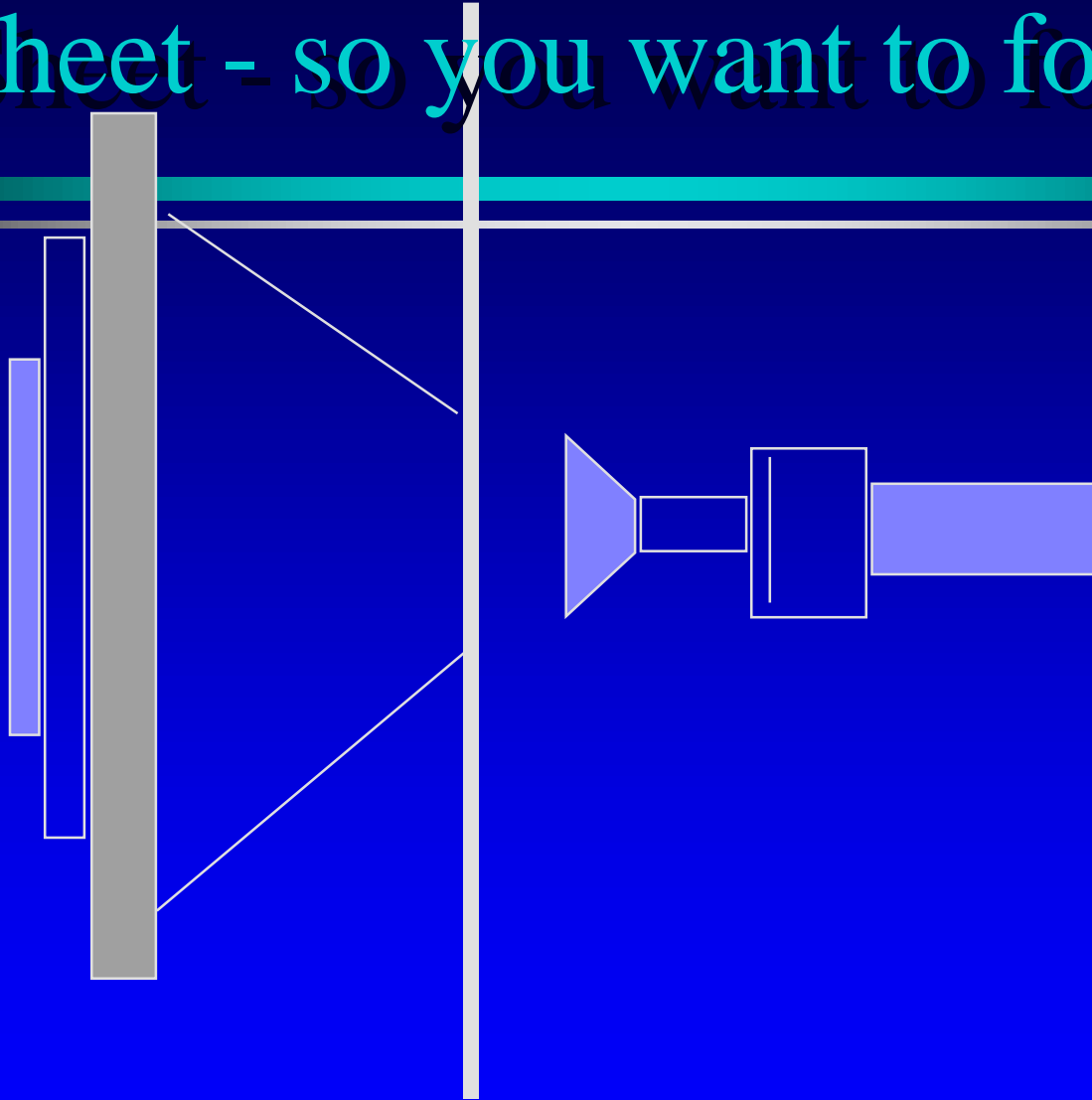

Sheet - so you want to form it.

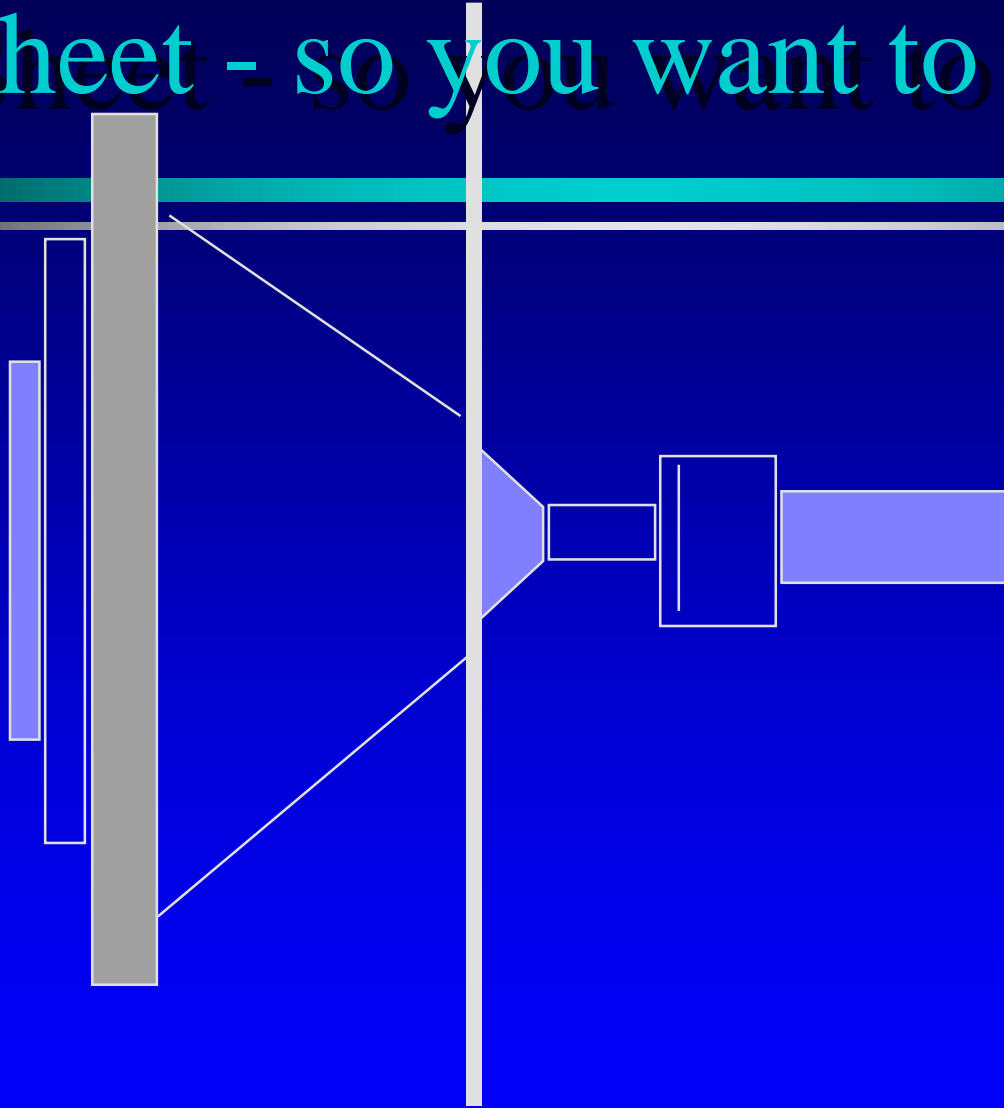

Sheet - so you want to form it.

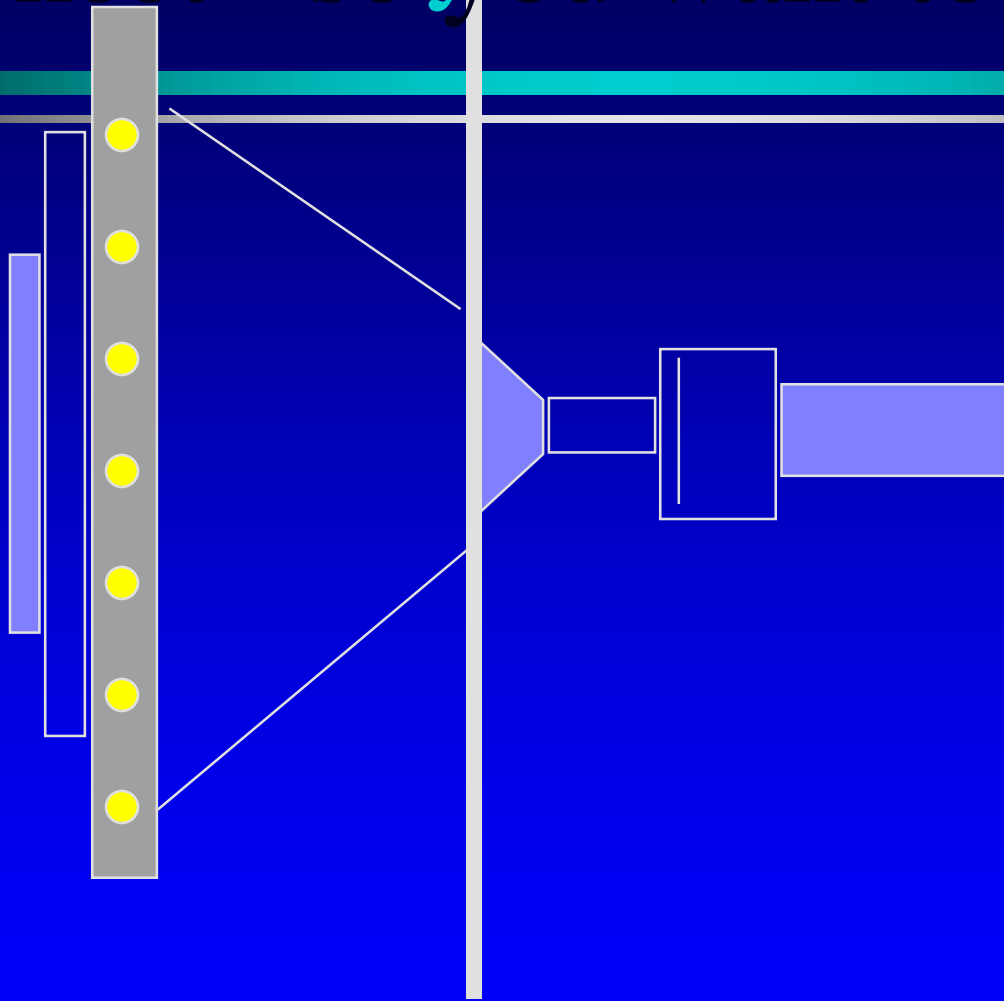

Sheet - so you want to form it.

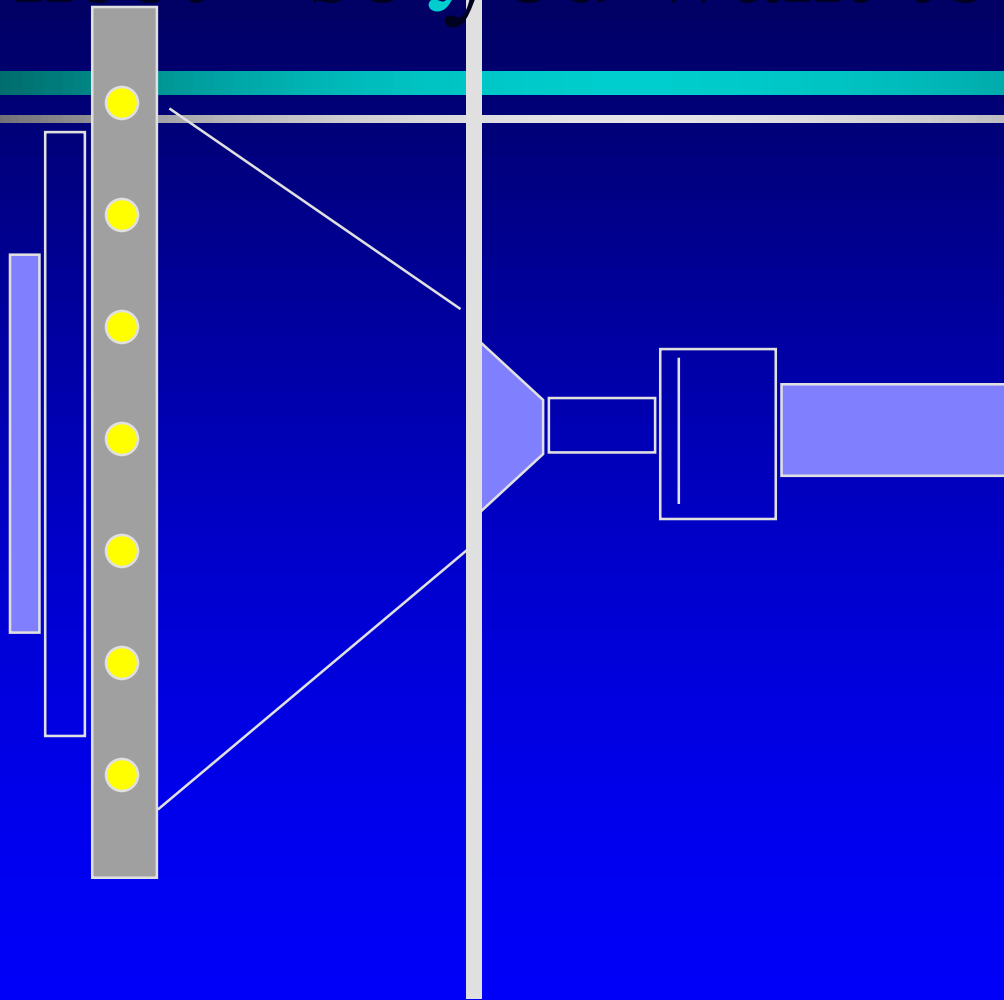

Sheet - so you want to form it.

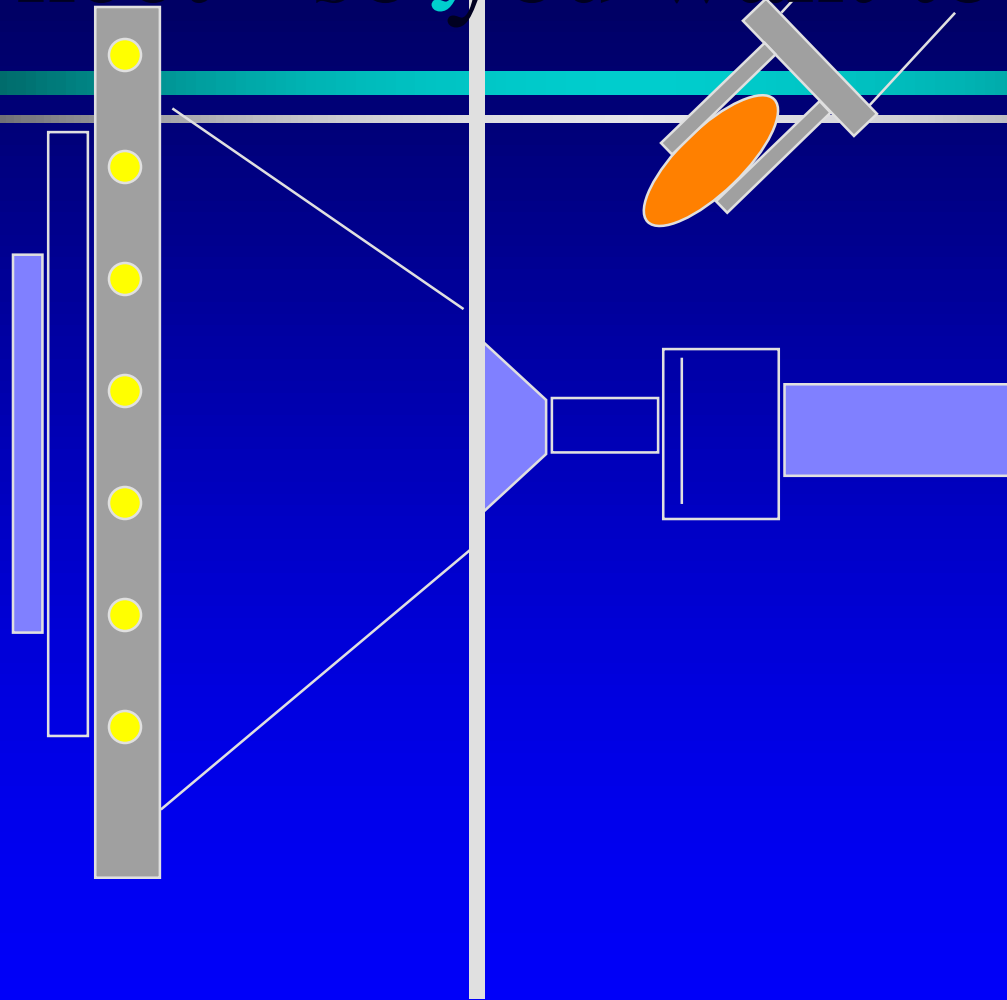

Sheet - so you want to form it.

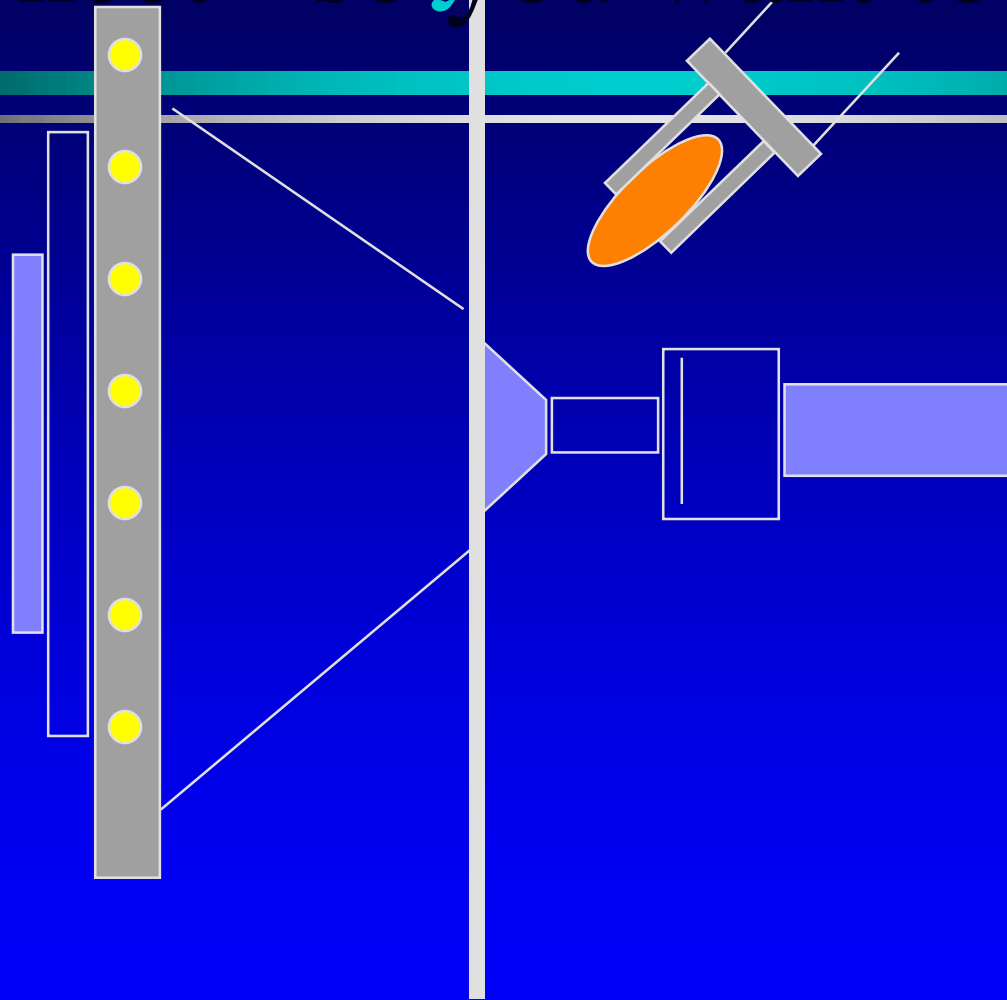

Sheet - so you want to form it.

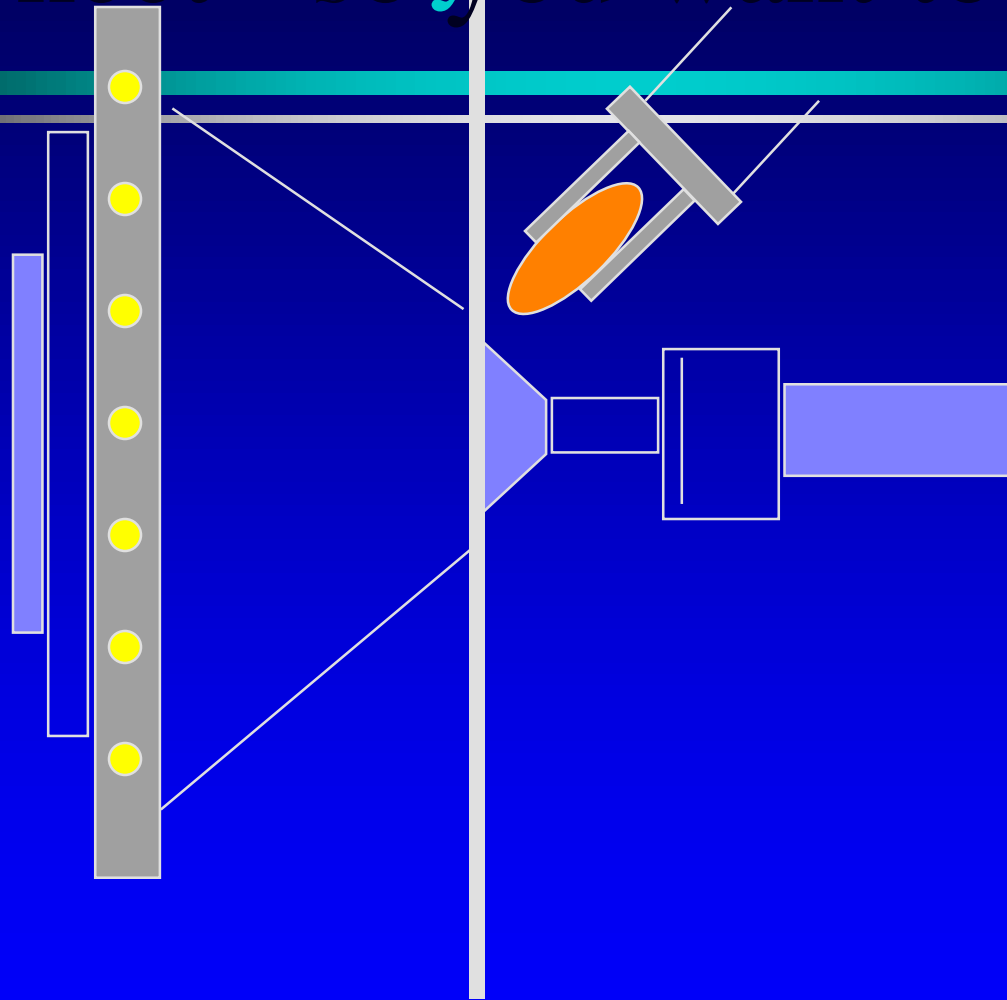

Sheet - so you want to form it.

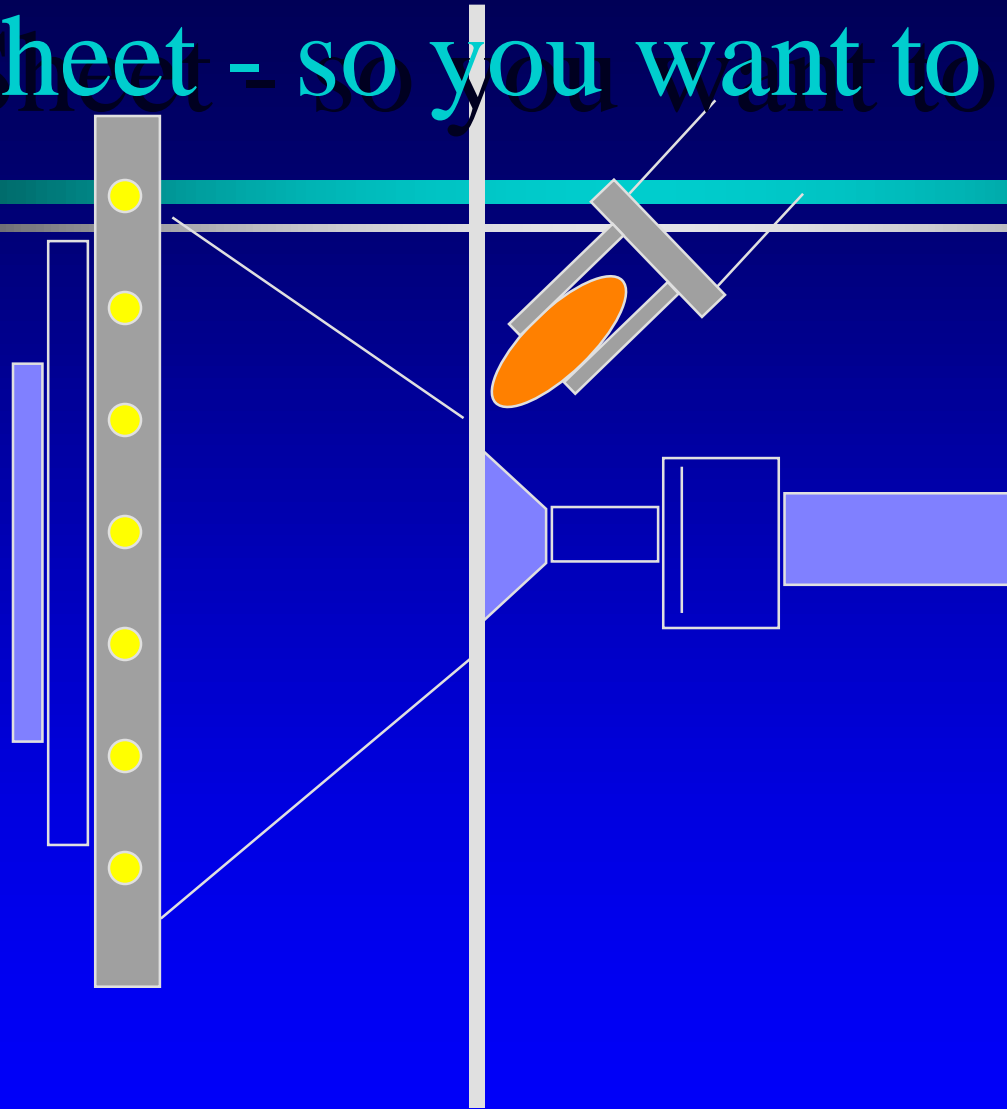

Sheet - so you want to form it.

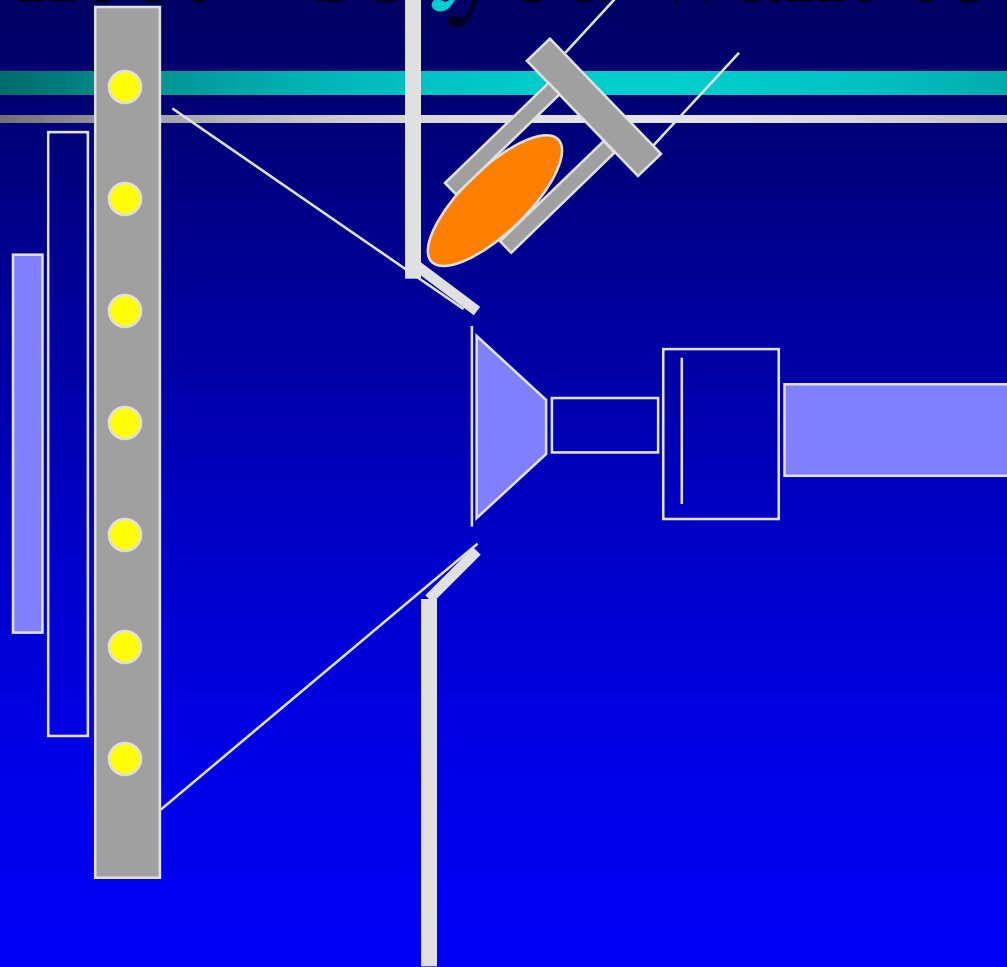



Sheet - so you want to form it.

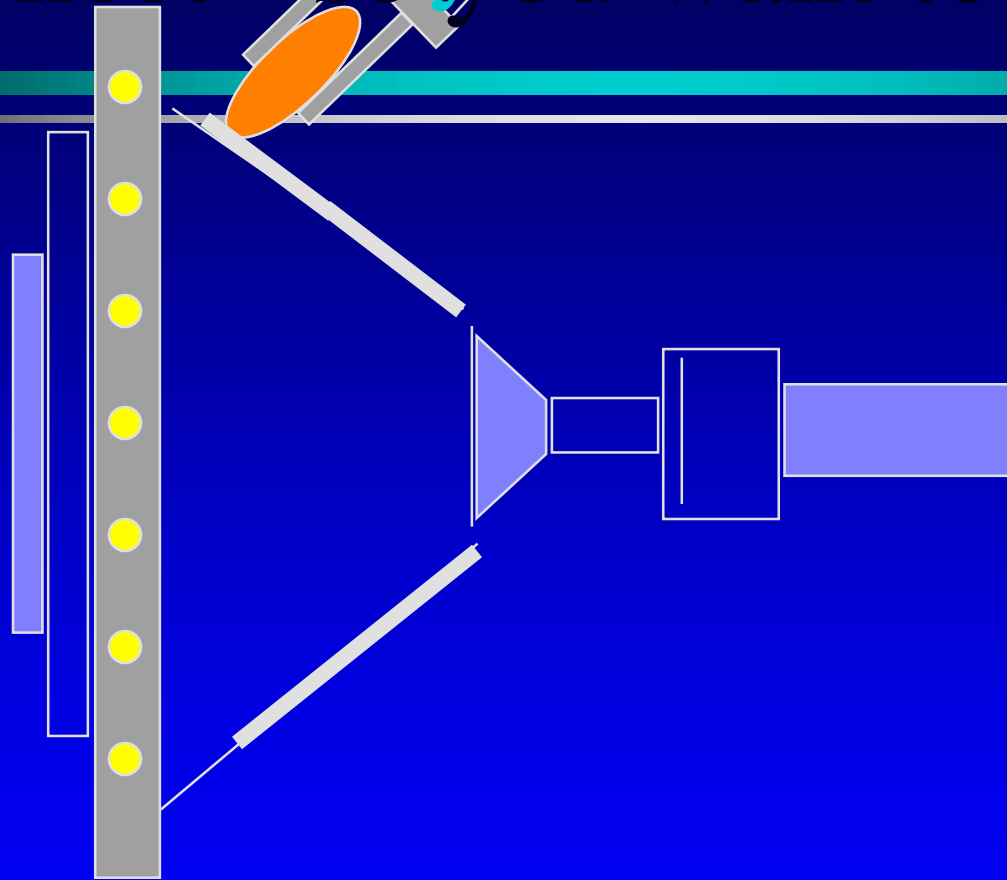

Sheet - so you want to form it.

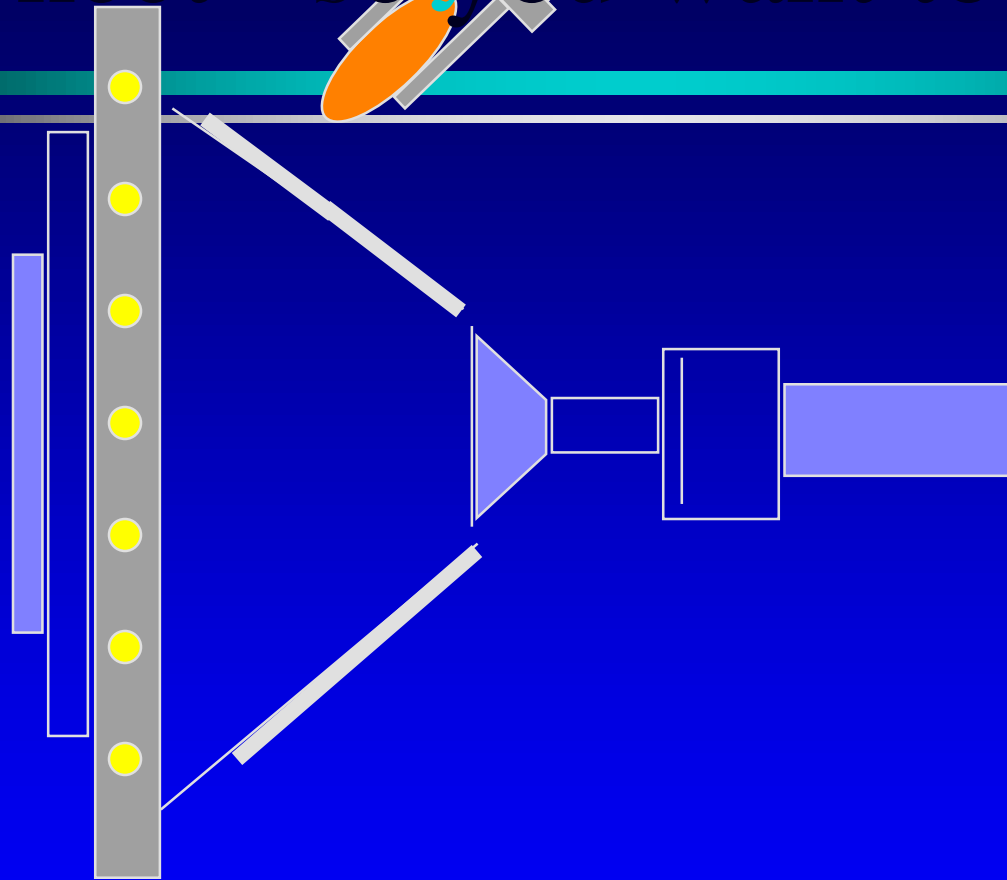

Sheet - so you want to form it.

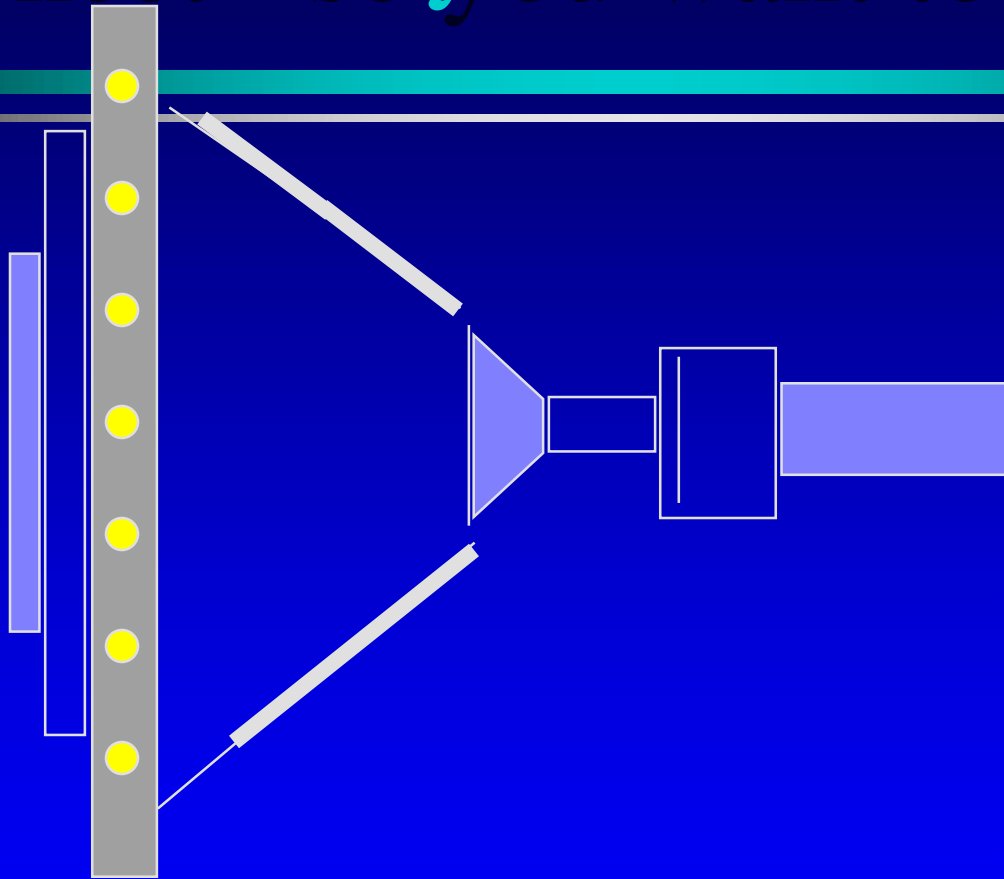

Sheet - so you want to form it.

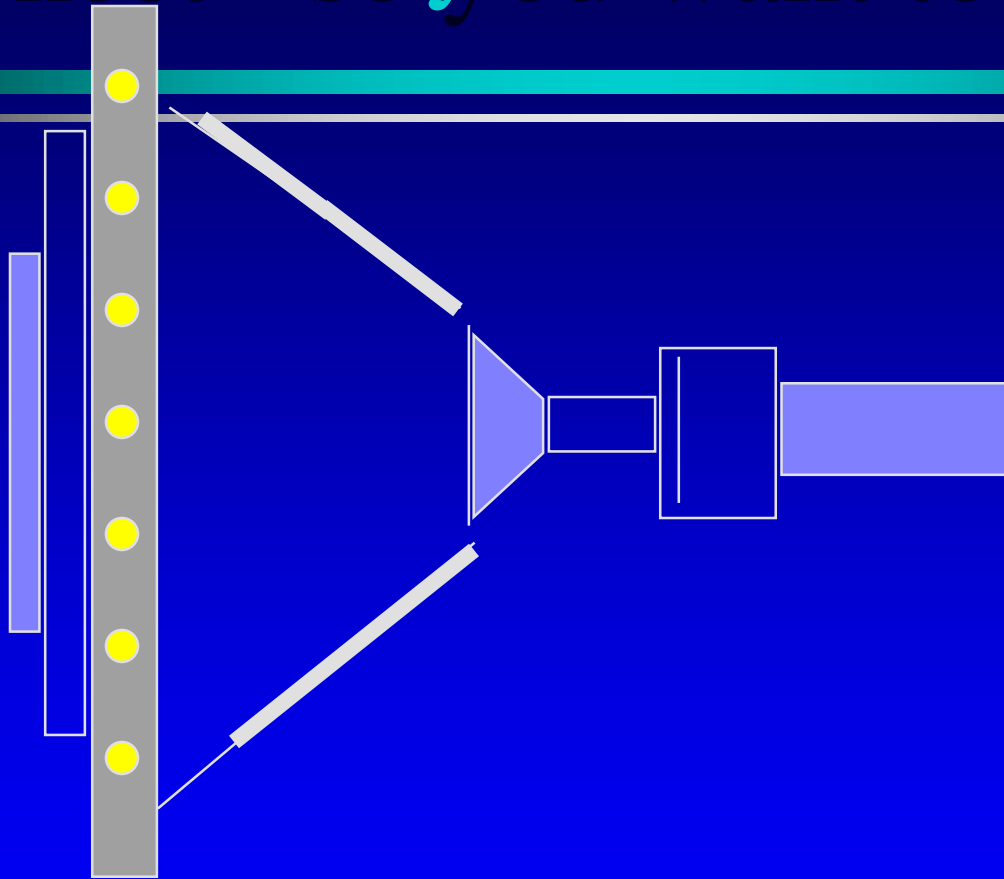

Sheet - so you want to form it.

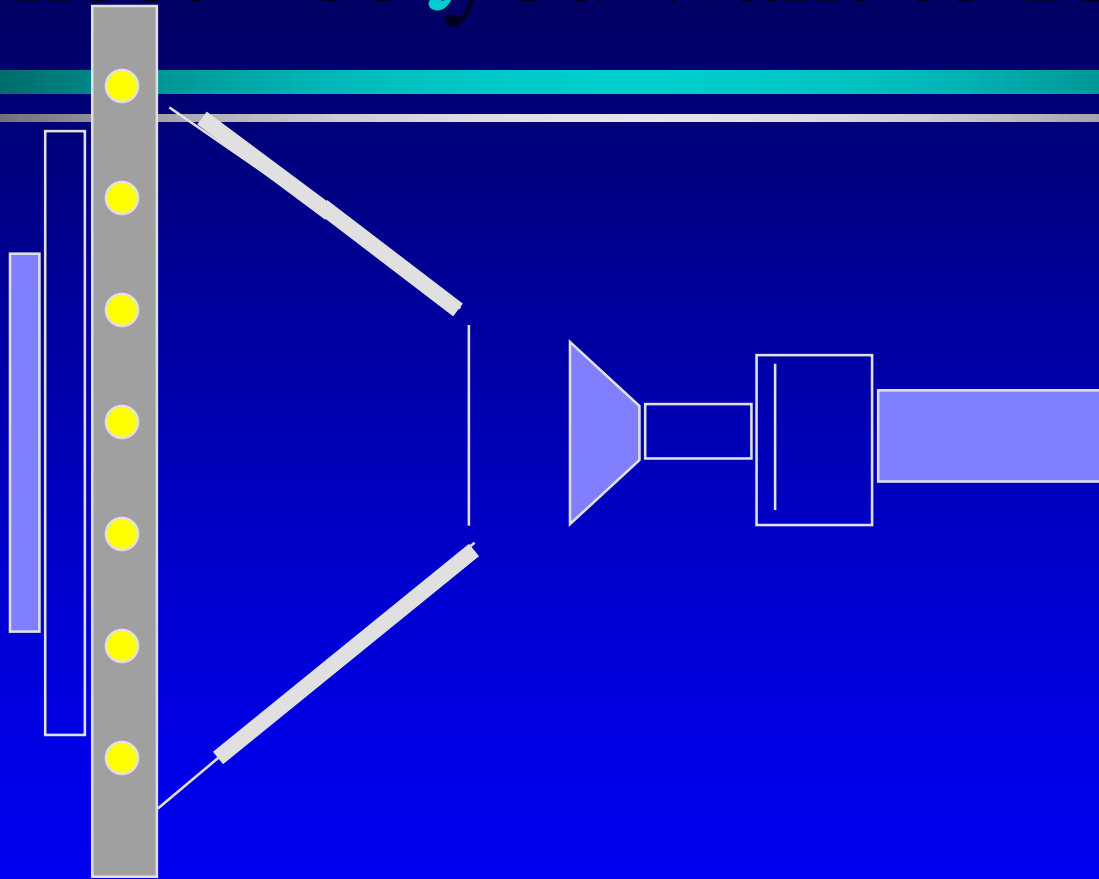

Sheet - so you want to form it.

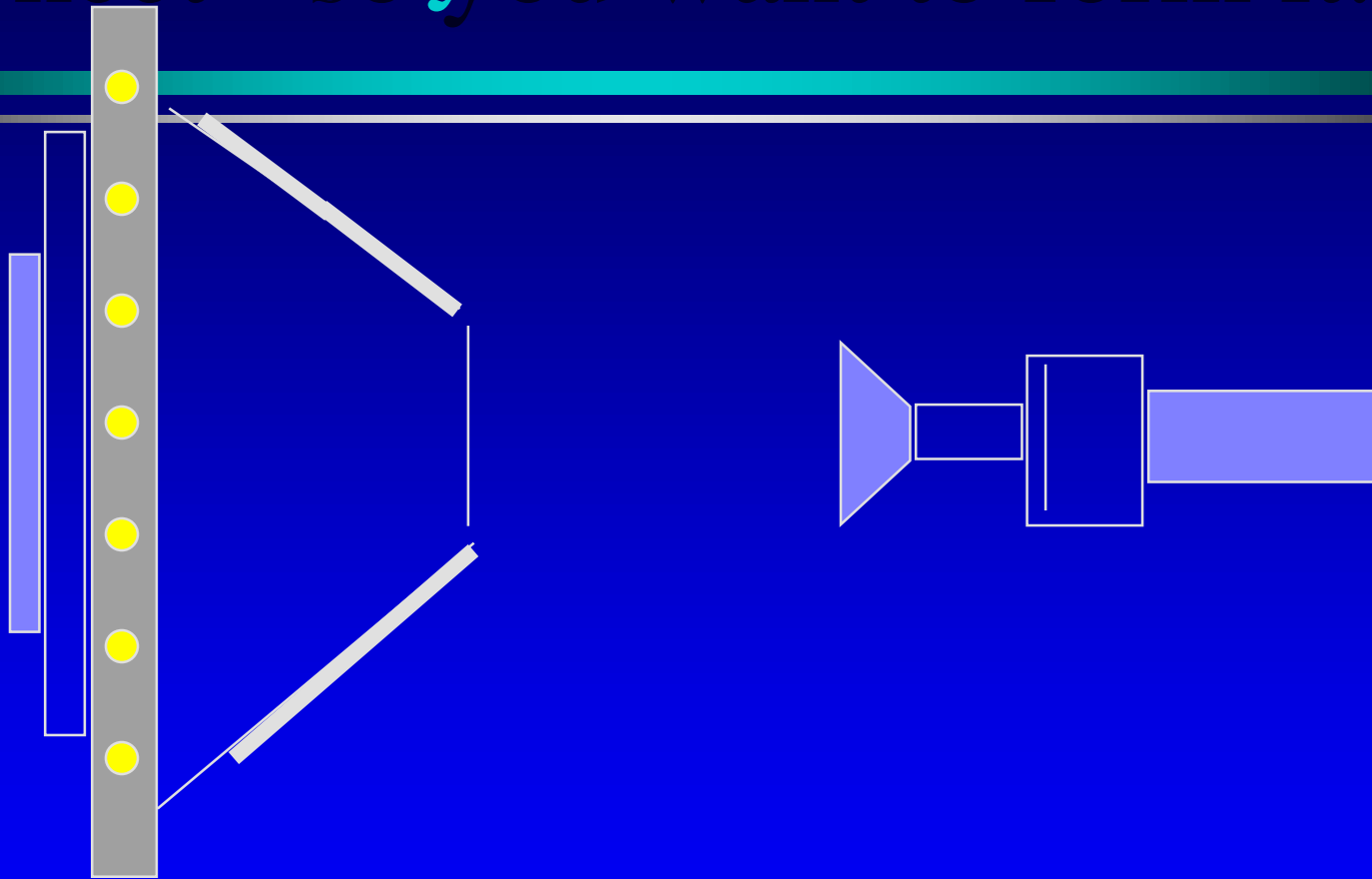

Sheet - so you want to form it.

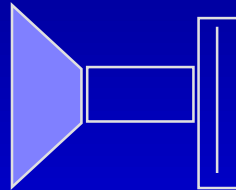
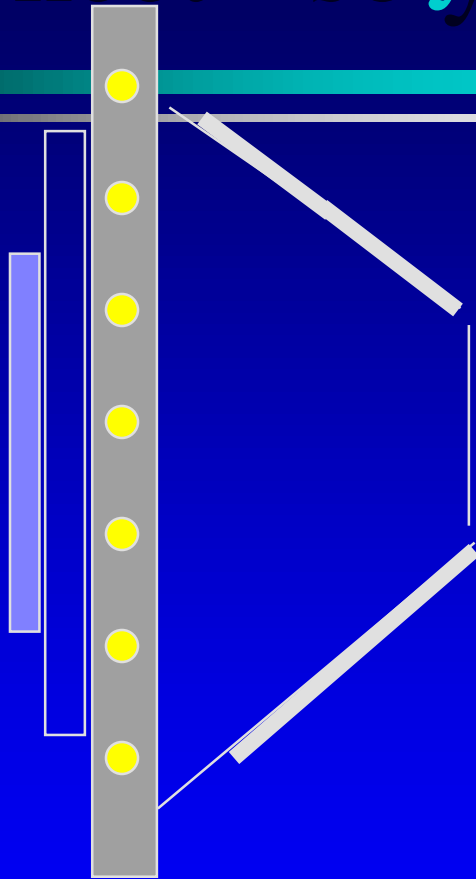

Sheet - so you want to form it.

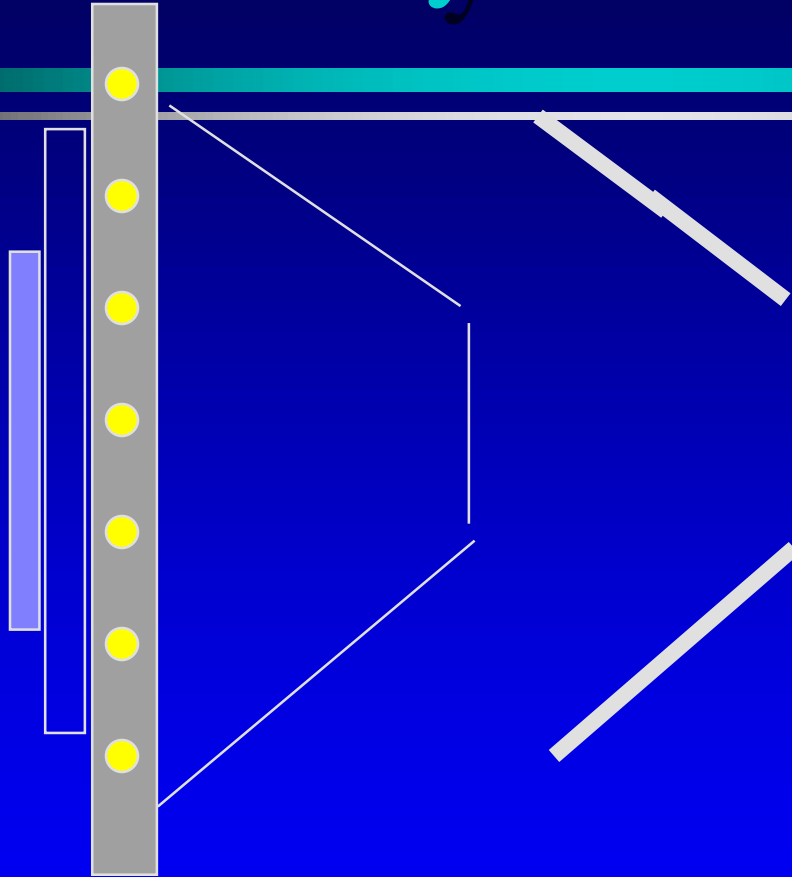

Sheet - so you want to form it.

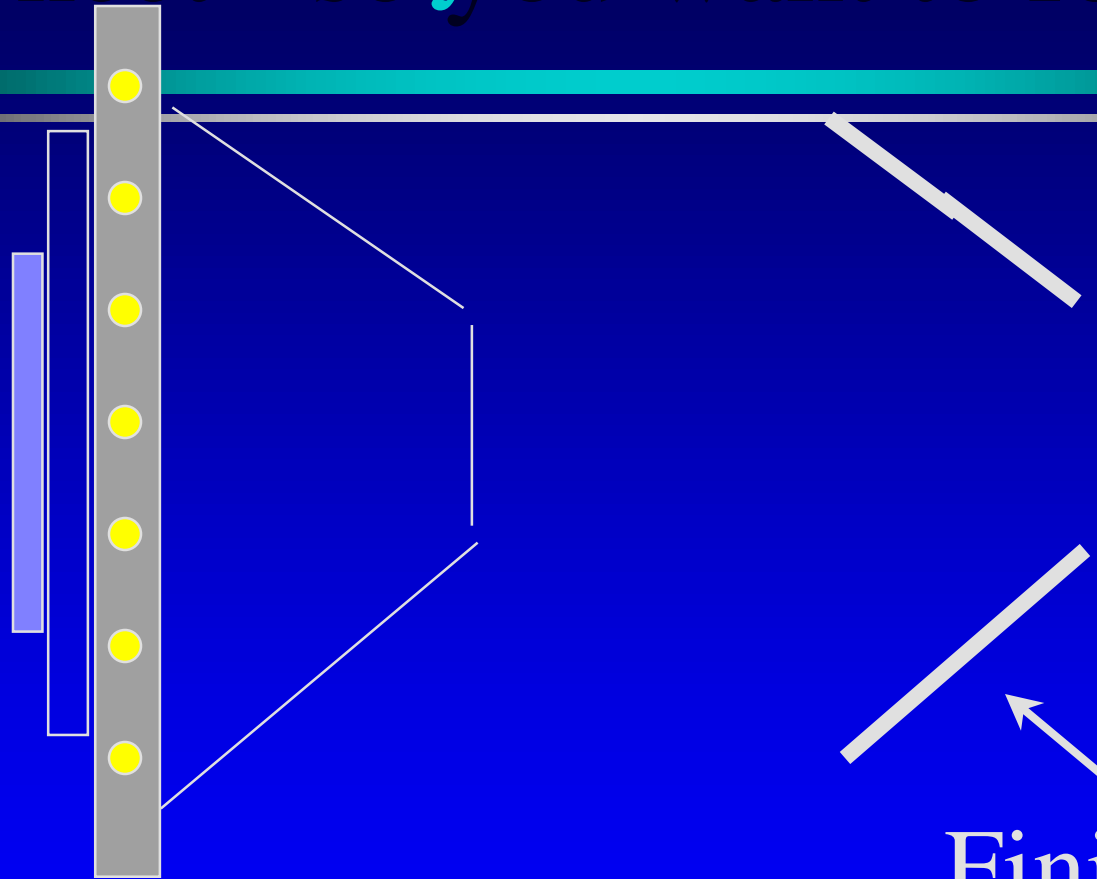

Finished  
Component

Sheet - so you want to form it.

Wok

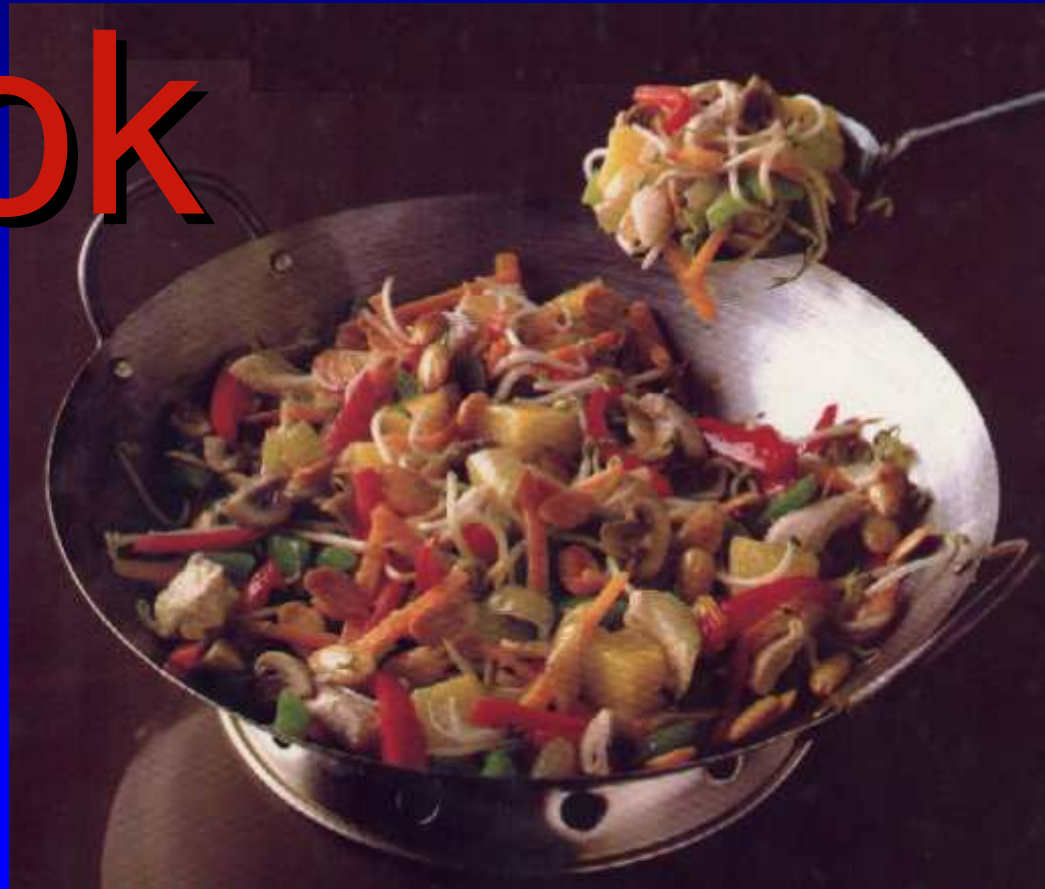

Sheet - so you want to form it.



Sheet - so you want to form it.

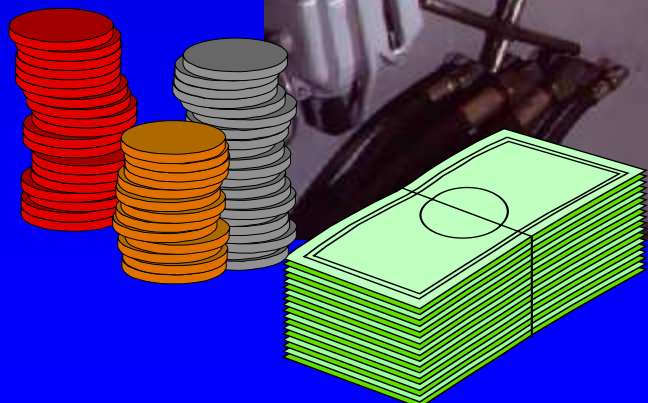



# Sheet - so you want to form it.

- ▶ Cor-ten
- ▶ Domex
- ▶ Red Diamond
- ▶ 50 B



The  
Angel's  
foot is a  
spinning

# Sheet - so you want to form it.

- ▶ Inconel Alloy
- ▶ Alloy 600
- ▶ MA 754
- ▶ MA 956



# Sheet - so you want to form it.

- ▶ Hastelloy
- ▶ Nimonic
- ▶ Titanium
- ▶ Nilomag



# Sheet - so you want to form it.

- ▶ Duplex
- ▶ Staybrite
- ▶ Nirosta
- ▶ Avesta



**Hygiene in  
Hospital is  
essential**

**Stainless  
Steel fully  
meets the  
demand.**

Sheet - so you want to form it.

THE

SPECIAL

MATERIALS





Sheet - so you want to form it.



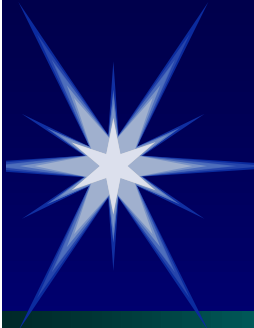

Sheet - so you want to form it.

Medical -  
Body Scanner

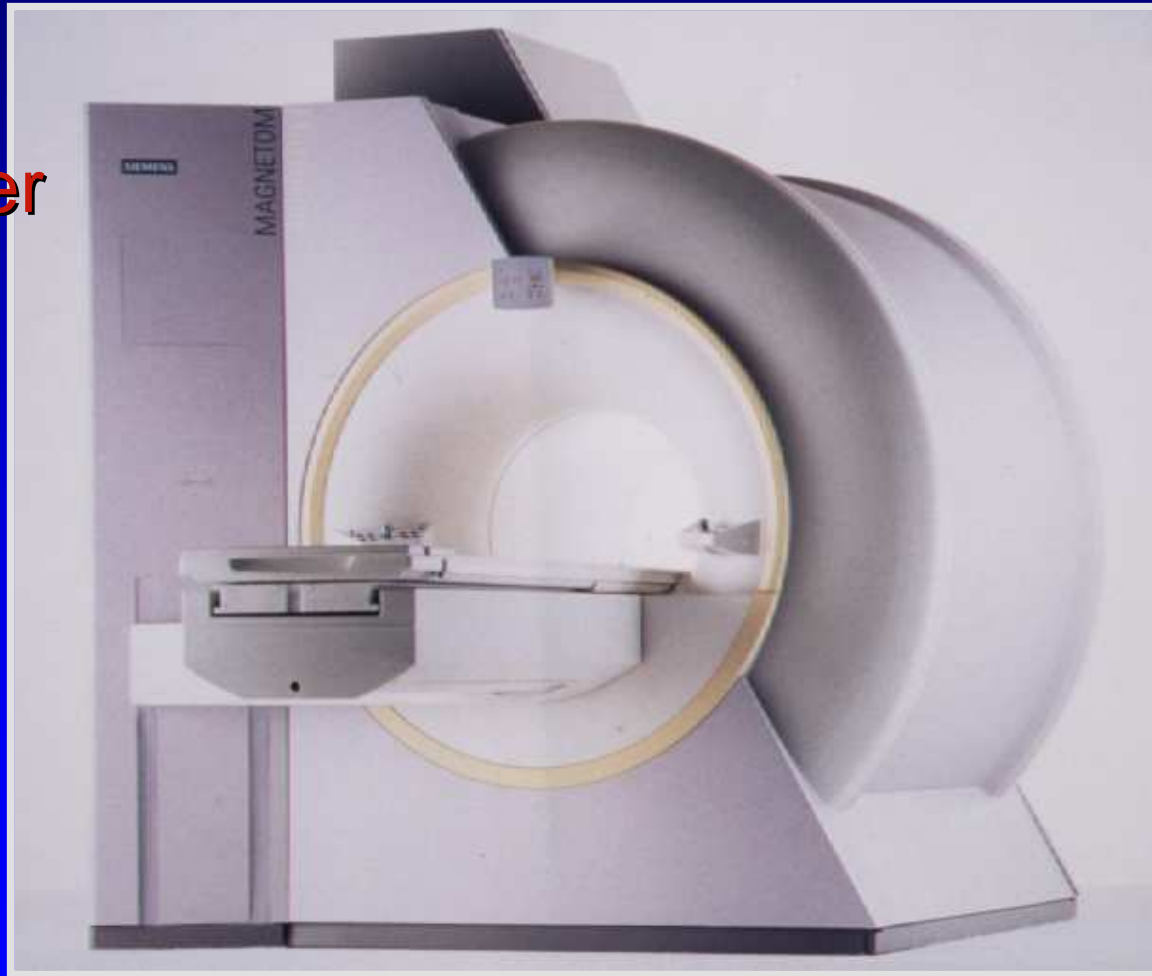

Sheet - so you want to form it.

## Wheel Manufacture



Sheet - so you want to form it.

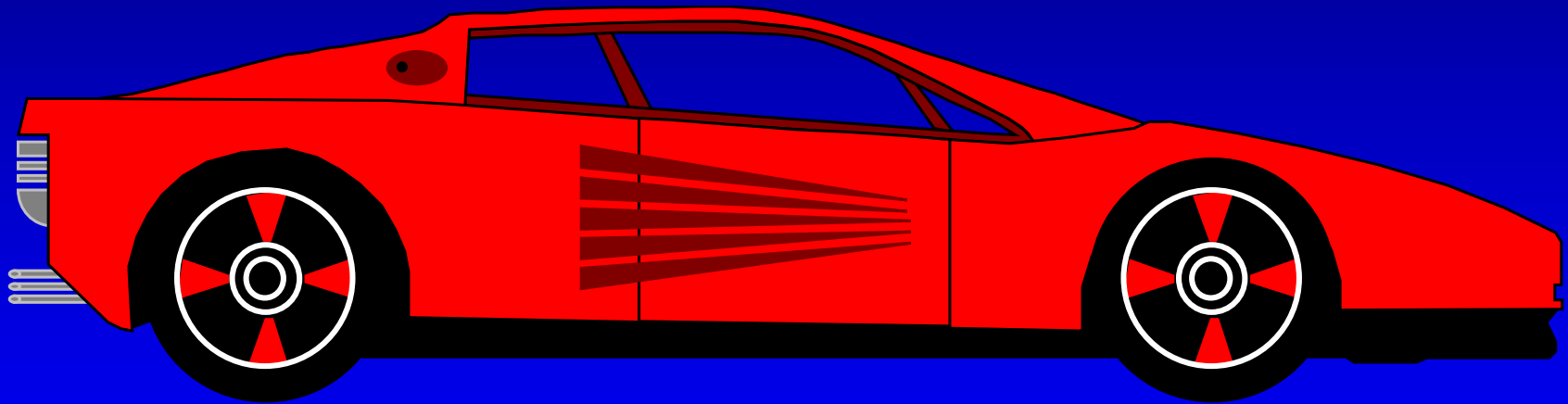

Sheet - so you want to form it.

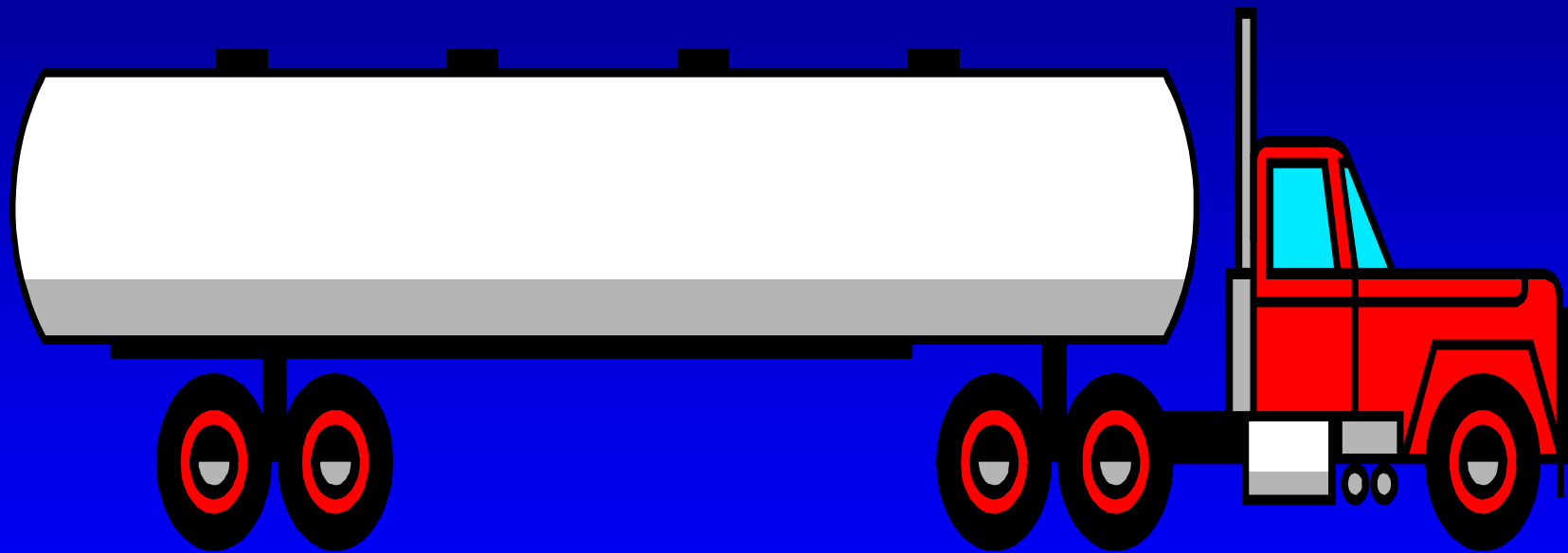

Sheet - so you want to form it.

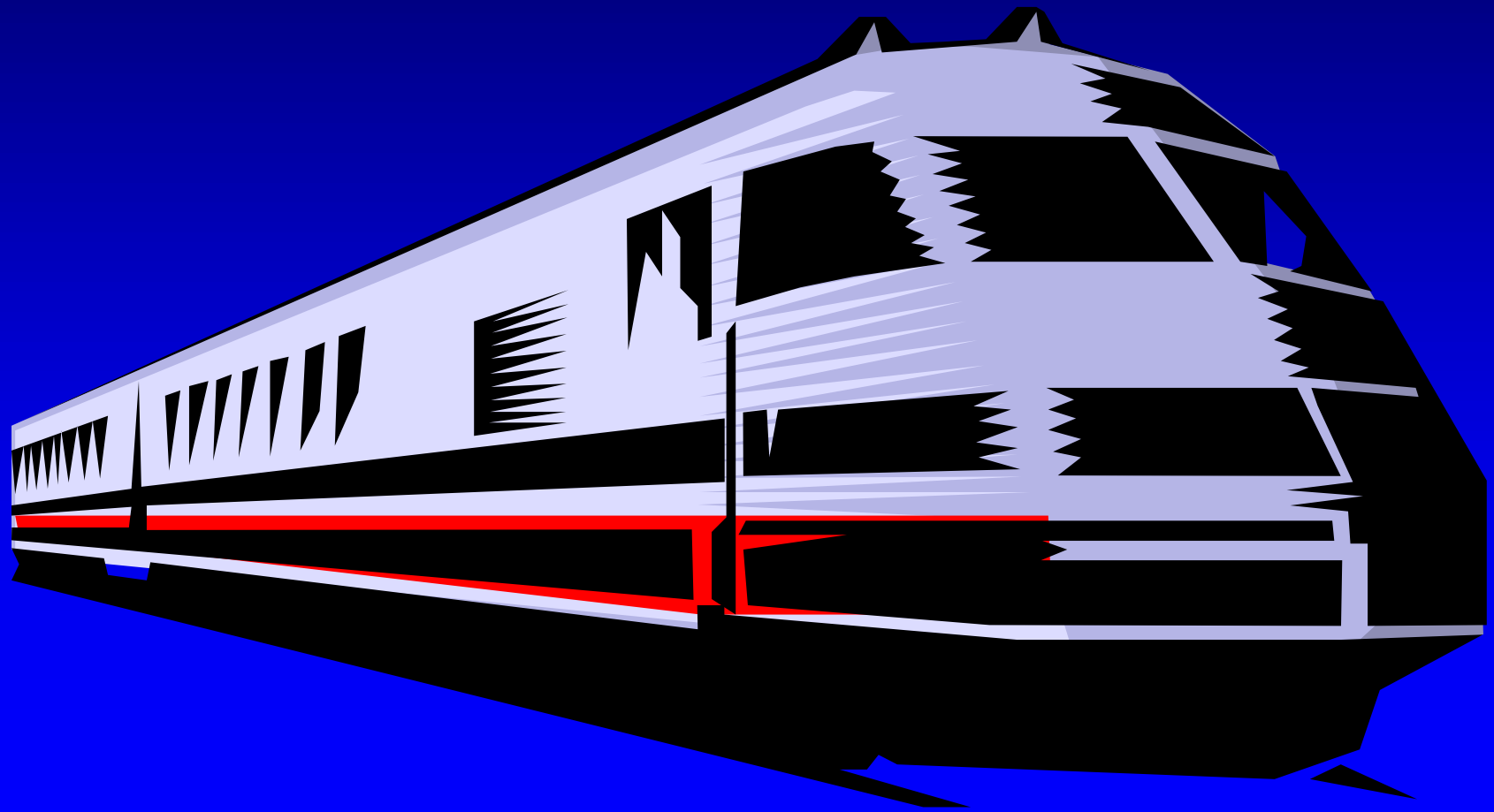

Sheet - so you want to form it.

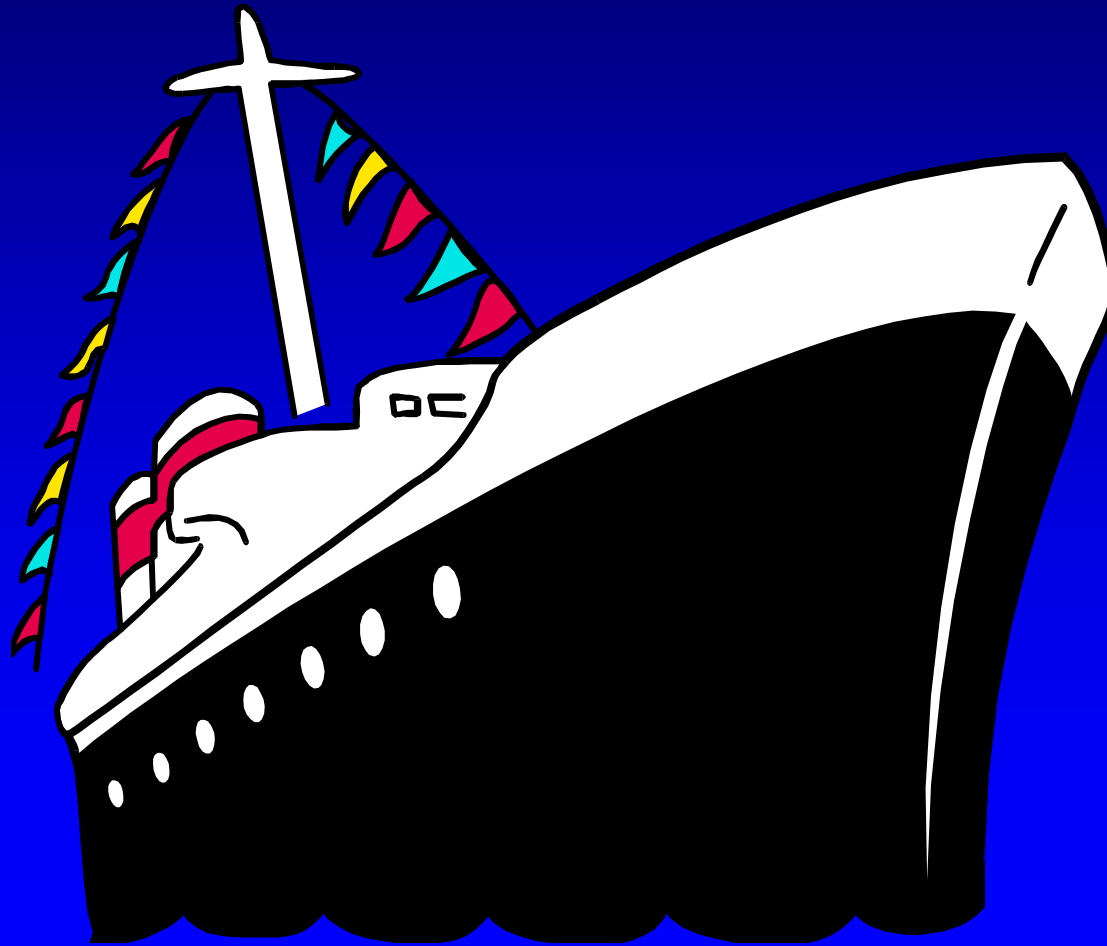

Sheet - so you want to form it.



Sheet - so you want to form it.



Sheet - so you want to form it.

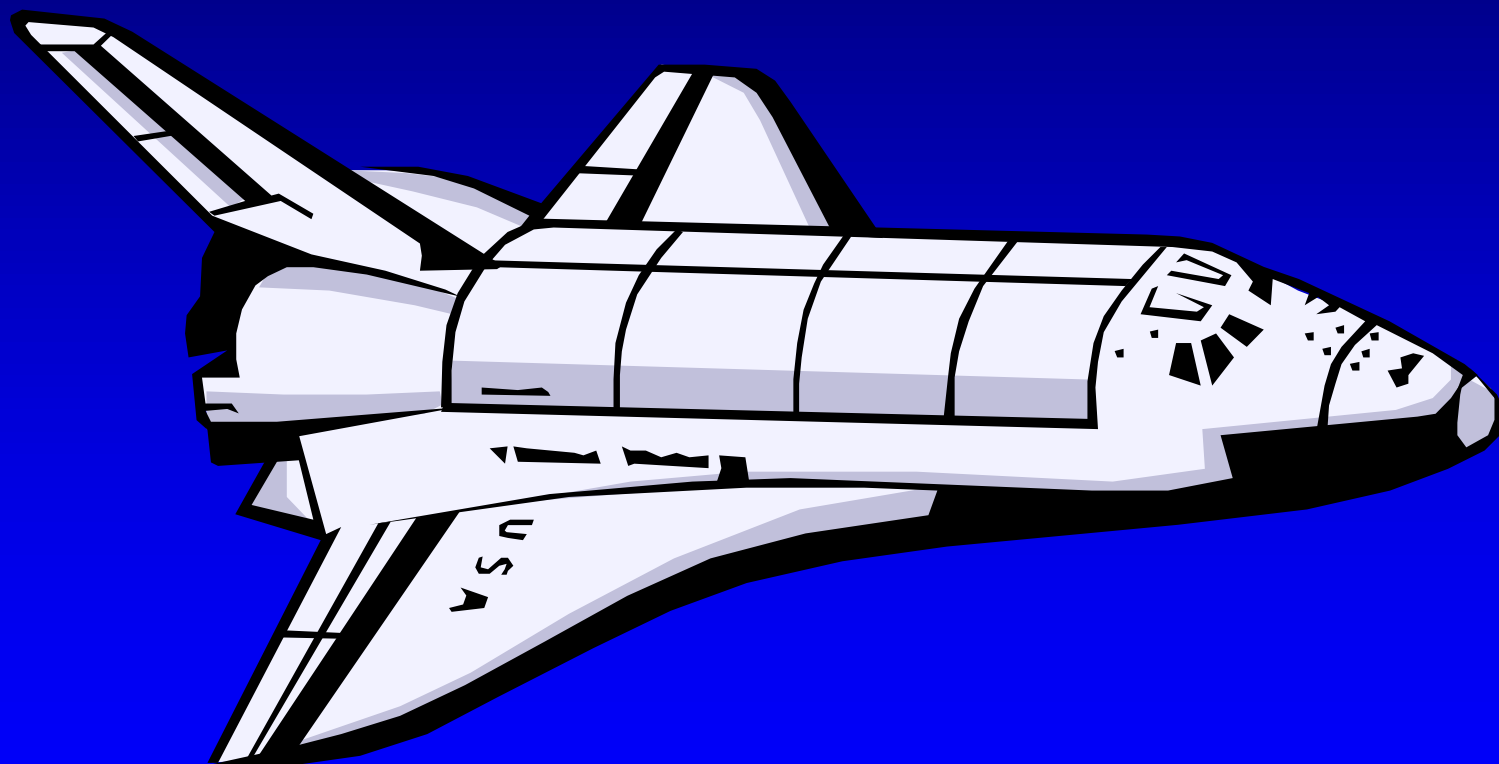

Sheet - so you want to form it.



Sheet - so you want to form it.



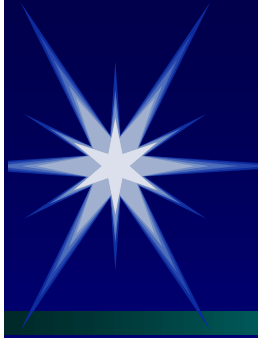

Sheet - so you want to form it.

➤ Sheet - so we can form it.

➤ Sheet - so we will form it.



**Sheet - so you want to form it.**



**METAL SPINNERS GROUP**

**Forming the Future in Metals Technology**

**Telephone - (0191) 2671011**

Sheet - so you want to form it.



Sheet - so you want to form it.



Sheet - so you want to form it.

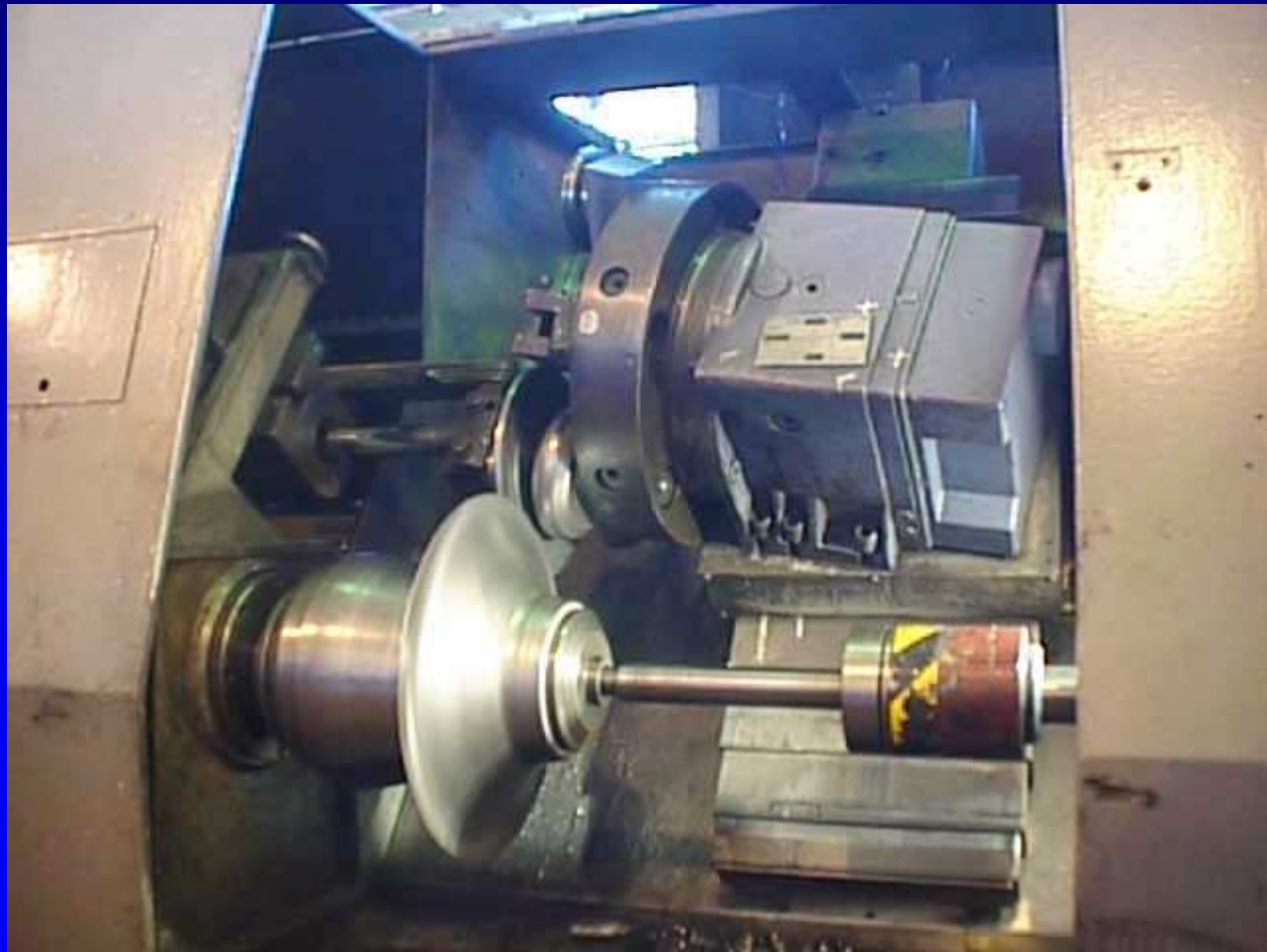

Sheet - so you want to form it.



Sheet - so you want to form it.



Sheet - so you want to form it.





Sheet - so you want to form it.

